

# EMERGENCY MANAGEMENT MAP:

5 Lowmore Avenue, Rokeby - 713779

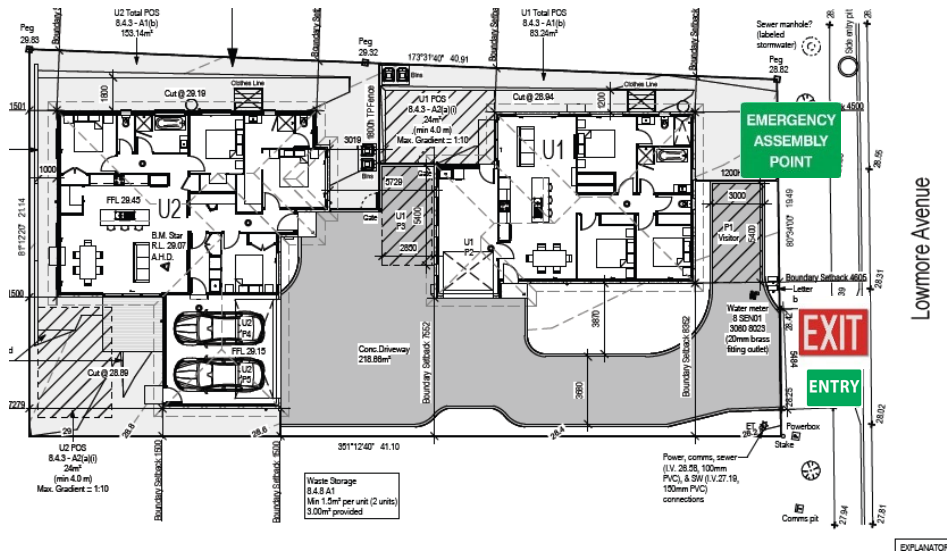

**A tidy site is a safe site**



## EMERGENCY CONTACT NUMBERS

**AMBULANCE**

**POLICE**

**FIRE SERVICE**

**000 or 112 (mobile)**

(BOTH NUMBERS ARE ACCESSIBLE WHILE MOBILE KEY PADS ARE LOCKED)

### **HOSPITAL**

Royal Hobart Hospital: 6166 8308  
48 Liverpool Street, Hobart  
(20 min drive)

### **EMERGENCY CENTRE**

Shoreline Doctors

Address:

6 Shoreline Drive, Howrah Tas

Phone:

03 6282 1333

Operating hours:

MON-FRI 8.30am – 5.00pm  
SAT/SUN: CLOSED

### **LOCAL INFORMATION**

**Police Station:**

13 14 44

**Poisons Information Centre:**

13 11 26 (Australia Wide)

**Telstra:**

13 22 55 (Australia Wide)

**Clarence Council:**

**03 6217 9500**

**TasNetworks/Aurora:**

132004

**Dial Before You Dig:**

1100

**TasGas:**

18 02 11

**Water Emergency:**

13 69 92

**Workplace Standards:**

1300 366 322

### **INTERNAL INFORMATION**

**Construction GM:**

Sam Plaschke 0417 505 197

**WHS Manager:**

Liam Brown 0447 747 664

**Site Supervisor:**

**Gabe Morgan 0429 016 446**



**WORK HEALTH SAFETY  
& ENVIROMENTAL  
MANAGEMENT PLAN  
(WHSEMP)**

**NEX**  
Building Group

**ARDEN**  
HOMES

**BRIGHTON**  
HOMES

**complete**

**mcdonald jones**

**MJH**  
RESIDENTIAL PROJECTS

**MOJO**  
HOMES

**MY**  
CHOICE

**SUPALOC**  
STEEL BUILDING SYSTEMS

**W Weeks**

**WILSON**  
HOMES

# NEX Building Group Details



# Business Addresses & ABNs

## ACT OFFICE (AXS Business Centre) (MJH)

**Address:** Building 2, Level 1, Corner of Gladstone & Tennant Streets, Fyshwick, ACT 2609  
**Postal:** PO Box 1224, Fyshwick, ACT 2609  
**Phone:** 02 6143 2000

## ARDEN HOMES

**Address:** Ground Floor, 31 Dalmore Dr, Scoresby, VIC 3179  
**Postal:** As above  
**Phone:** 03 8787 1300

## BRIGHTON HOMES & BRIGHTON PROJECTS

**Address:** 3926 Pacific Highway, Loganholme, QLD 4129  
**Postal:** PO Box 3220 Loganholme, QLD 4129  
**Phone:** 07 3188 5500

## HONEYSUCKLE HEAD OFFICE

**Address:** Level 5, Honeysuckle Drive, Newcastle, NSW 2300  
**Postal:** PO Box 2092, Dangar, NSW 2309  
**Phone:** 02 4918 2200

## MID NORTH COAST (MJH & Mojo)

**Address:** 3/145 Horton St, Port Macquarie, NSW 2444  
**Postal:** DX 7416 Port Macquarie, NSW 2444  
**Phone:** 02 5525 2500

## MJH MULTI & COMPLETE HOMES

**Address:** 2 Solent Circuit, Norwest, NSW 2153  
**Postal:** PO Box 7994, Baulkham Hills, NSW 2153  
**Phone:** 02 8848 6011

## SOUTH COAST OFFICE (MJH & Mojo)

**Address:** 142 Lake Entrance Road, Oak Flats, NSW 2529  
**Postal:** PO Box 275, Oak Flats, NSW 2529  
**Phone:** 02 4230 6800

## SYDNEY OFFICE (MJH & Mojo)

**Address:** 2 Solent Circuit, Baulkham Hills, NSW 2153  
**Postal:** PO Box 7994, Baulkham Hills, NSW 2153  
**Phone:** 02 8848 6000

## THORNTON OFFICE (MJH & Mojo)

**Address:** 9B Huntingdale Drive, Thornton, NSW 2322  
**Postal:** PO Box 340, East Maitland, NSW 2323  
**Phone:** 02 4918 2200

## WEEKS HOMES

**Address:** 45 Richmond Road, Keswick SA 5035  
**Postal:** As above  
**Phone:** 1800 493 357

## WILSON HOMES & WILSON PROJECTS (NORTHERN OFFICE)

**Address:** Level 1, 78-96 Wellington St, Launceston TAS 7250  
**Postal:** DX 116 Hobart, TAS 7000  
**Phone:** 1300 595 050

## WILSON HOMES & WILSON PROJECTS (SOUTHERN OFFICE)

**Address:** 250 Murray St, Hobart TAS 7000  
**Postal:** DX 116 Hobart, TAS 7000  
**Phone:** 03 6234 6444

ENTITY NAME	ABN	LICENCE	Business Name (ASIC Registered)
Arden Homes Pty Ltd	68 146 213 970	CDB-U 48276	Arden Homes
McDonald Jones Homes Pty Ltd	82 003 687 232	41628	McDonald Jones Homes
McDonald Jones Homes (Sydney) Pty Ltd	65 135 576 680		
McDonald Jones Homes (South Coast) Pty Ltd	47 131 091 980		
McDonald Jones Homes (Canberra) Pty Ltd	64 150 533 298	20121296	
McDonald Jones Communities Pty Limited	42 603 418 364	280160C	MJH Multi Complete by McDonald Jones
Mojo Homes Pty Ltd	31 166 754 696	269829C	Mojo Homes
NEX Building Group Pty Ltd	59 089 524 050	1250787	NEX Building Group Brighton Homes
Weeks Homes Pty Ltd	97 008 087 278	G10238	Weeks Homes
Wilson Homes Tasmania Pty Limited	96 126 636 897	248660581	Wilson Homes

# Table of Contents

<b>Part (A)</b>	.....	1
<b>Part (B)</b>	.....	2
<b>NEX Building Group Details</b>	.....	2
<b>Business Addresses &amp; ABNs</b>	.....	3
<b>Glossary of Terms &amp; Abbreviations</b>	.....	8
<b>SECTION 1.</b>	Introduction .....	9
1.1	Overview & Purpose.....	9
1.2	Legal & Other Requirements .....	9
1.3	Development, Review & Communication of WHSEMP .....	10
<b>SECTION 2.</b>	WHS & Environmental Policies .....	11
<b>SECTION 3.</b>	Business & Project Organisational Chart .....	13
<b>SECTION 4.</b>	Responsibilities .....	14
4.1	Director (PCBU & Officer).....	14
4.2	Chief Executive Officer (Officer) .....	14
4.3	Regional Construction Director (Officer) .....	15
4.4	Regional Building Manager (Officer).....	17
4.5	Construction Manager .....	18
4.6	Area Manager .....	19
4.7	Site Supervisor (Worker) .....	19
4.8	Work Health & Safety Manager .....	21
4.9	Return to Work Coordinator (External Provider AON).....	22
4.10	WHS Advisor/WHS Site Coordinator (Worker) .....	22
4.11	Employee (Worker).....	23
4.12	Contractor (PCBU & Worker) .....	23
4.13	First Aid Officer .....	24
4.14	Purchasing/Procurement Team .....	24
<b>SECTION 5.</b>	Objectives & Targets .....	25
<b>SECTION 6.</b>	Design .....	26
<b>SECTION 7.</b>	Performance Reporting .....	29
<b>SECTION 8.</b>	Communication & Consultation.....	30

<b>SECTION 9.</b>	Training & Competency.....	31
9.1	Construction General Induction .....	31
9.2	Internal Staff .....	31
9.3	Contractors, Sub-contractors & their Workers .....	32
<b>SECTION 10.</b>	On-site Management of Hazards and Risks (Site Rules) .....	34
10.1	Site Security.....	34
10.2	Site Entry & Parking .....	34
10.3	General Access & Egress .....	34
10.4	Construction Site Fencing .....	34
10.5	Site Safety Signage.....	35
10.6	Site Visitors .....	35
10.7	Site Specific Risk Assessment (SSRA).....	36
10.8	WHS Issue Resolution.....	36
10.9	Site Cleanliness (Housekeeping) .....	36
10.10	Amenities .....	37
10.11	Personal Protective Equipment.....	37
10.12	Traffic Management.....	39
10.13	Asbestos .....	40
10.14	Crystalline Silica .....	41
10.15	Underground Essential Services/Utilities (Gas, Water, Electricity, Sewer & Comms.) ....	41
10.16	Working Near Underground Electric Lines .....	42
10.17	Working Near Overhead Electric Lines .....	43
10.18	Work Near Energised Electrical Installations (Other) .....	47
10.19	Demolition .....	47
10.20	Excavations .....	48
10.21	Swimming Pools.....	49
10.22	Confined Spaces .....	49
10.23	Temporary Supports – Propping and Bracing .....	50
10.24	Powered Mobile Plant & Equipment (Cranes, Concrete Pumps, EWP etc.) .....	51
10.25	Working at Heights Below 2m.....	53
10.26	Working at Heights 2m & Above .....	54
10.27	Scaffolding.....	54
10.28	Falls through Excavations, Penetrations & Floor Openings .....	67
10.29	Falling Objects.....	67
10.30	Harnesses .....	68
10.31	Ladders.....	68
10.32	Working Below Other Trades .....	70
10.33	Dangerous Protrusions – Impaling Aspects .....	70

10.34	High-Risk Work Licences .....	70
10.35	Lifting Equipment .....	71
10.36	Inspection of Lifting Equipment .....	71
10.37	Hazardous Tasks - Manual Handling/Lifting .....	72
10.38	Electrical Tools & Equipment.....	72
10.39	Portable Generators.....	73
10.40	Machinery Guarding.....	74
10.41	Nine-Inch 9” (225mm) Grinders .....	74
10.42	Nail Guns .....	74
10.43	Explosive Power Tools.....	75
10.44	Welding and Cutting (Hot Work) .....	75
10.45	Laser Equipment .....	76
10.46	Electronic Devices .....	76
10.47	Sun Protection & Heat Exposure (Sun Smart).....	77
10.48	Adverse Weather & Climatic Conditions.....	77
10.49	Remote & Isolated Work (i.e., Lone Workers) .....	77
10.50	Young and Inexperienced Workers.....	78
10.51	Alcohol and Illicit Drugs .....	78
10.52	Fatigue .....	78
10.53	Bullying, Discrimination & Harassment .....	79
10.54	Chain of Responsibility.....	79
10.55	General Prohibitions - Other .....	80
<b>SECTION 11.</b>	<b>Environmental Management.....</b>	<b>81</b>
11.1	Soil Stockpiles .....	81
11.2	Water Bodies .....	81
11.3	Waste.....	82
11.4	Dust, Smoke & Odours.....	82
11.5	Noise & Vibration .....	83
11.6	Hazardous Chemicals/Substances .....	84
11.7	Contaminated Land .....	84
11.8	Environmental Protection Agency (E.P.A).....	84
11.9	Archaeology & Cultural Heritage.....	84
11.10	Flora & Fauna .....	85
<b>SECTION 12.</b>	<b>Emergency Preparedness.....</b>	<b>86</b>
12.1	Incidents & Near Misses .....	86
12.2	Emergency Procedures and First Aid .....	86
12.3	Electric Shock .....	87
12.4	In the Event of a Serious Accident – Notifiable Incident.....	87



12.5	Fire & Other Evacuation Procedure .....	88
12.6	Critical Incident Response Flowchart .....	90
<b>SECTION 13.</b>	<b>Risk Management.....</b>	<b>91</b>
13.1	Hazard Identification Procedure.....	91
13.2	Hierarchy of Control Measures .....	92
13.3	Risk Assessment Matrix.....	93
<b>SECTION 14.</b>	<b>Safe Work Method Statements (SWMS) .....</b>	<b>96</b>
14.1	Safe Work Method Statements Content.....	97
14.2	Safe Work Method Statements Review.....	97
<b>SECTION 15.</b>	<b>Inspection and Testing.....</b>	<b>98</b>
15.1	Mobile Plants .....	98
15.2	Hire Equipment .....	98
15.3	Handheld Power Tools.....	98
15.4	Safety Harnesses & Lanyards .....	98
15.5	Other Equipment .....	98
<b>SECTION 16.</b>	<b>Materials Handling, Storage &amp; Delivery .....</b>	<b>99</b>
16.1	Materials Handling and Storage .....	99
16.2	Flammable Substances & Combustible Liquids .....	99
16.3	Deliveries .....	99
<b>SECTION 17.</b>	<b>Hazardous Chemicals/Substances .....</b>	<b>100</b>
<b>SECTION 18.</b>	<b>Health Surveillance &amp; Monitoring .....</b>	<b>103</b>
<b>SECTION 19.</b>	<b>Rehabilitation &amp; Return to Work .....</b>	<b>104</b>
<b>SECTION 20.</b>	<b>Measurement, Evaluation &amp; Review .....</b>	<b>107</b>
20.1	Site Inspections & Contractor Review .....	107
20.2	Systems Audits Internal .....	107
20.3	Contractor Compliance.....	108
20.4	Disciplinary Procedures.....	108
20.5	Non-compliance Notices.....	109
<b>SECTION 21.</b>	<b>Documentation and Data Control .....</b>	<b>110</b>
21.1	Document Control .....	110
21.2	General Records .....	111

# Glossary of Terms & Abbreviations

<b>AS/NZS</b>	Australian & New Zealand Standard	<b>RTW</b>	Return To Work
<b>HIRAC</b>	Hazard Identification, Risk Assessment and Control	<b>SDS</b>	Safety Data Sheets
<b>HRCW</b>	High-Risk Construction Work	<b>SOP</b>	Standard Operating Procedures
<b>HRWL</b>	High-Risk Work License	<b>SSRA</b>	Site-Specific Risk Assessment
<b>HSR</b>	Health & Safety Representative	<b>SWMS</b>	Safe Work Method Statement
<b>HV</b>	High Voltage	<b>Vendor</b>	Supplier, contractor, business engaged by NEX Building Group
<b>LV</b>	Low Voltage	<b>WHS</b>	Work Health and Safety
<b>O/H</b>	Overhead	<b>WHS ACT</b>	Work Health & Safety Act ACT 2011, QLD 2011, NSW 2011, TAS 2012, SA 2012, OH&S VIC 2004
<b>OHS</b>	Occupational Health & Safety	<b>WHS Reg</b>	Work Health & Safety Regulation ACT 2011, QLD 2011, NSW 2017, TAS 2012, SA 2012, OH&S VIC 2017
<b>OSC</b>	On Site Companion (Software System)	<b>WHSE</b>	Work Health Safety & Environment
<b>PC</b>	Principal Contractor	<b>WHSEMP</b>	Work Health Safety & Environmental Management Plan
<b>PCBU</b>	Person Conducting a Business or Undertaking		
<b>PPE</b>	Personal Protective Equipment		
<b>RCD</b>	Residual Current Device		

## MEANING OF A WORKER:

A person is a worker if the person carries out work in any capacity for a PCBU including work performed under a contract, and in relation to the work, is an employee for the purpose of assessment of Pay As You Go PAYG withholding under the Taxation Administration Act 1953.

The person conducting the business or undertaking is also a worker if the person is an individual who carries out work in that business or undertaking.

If doubt exists about whether a person is a worker, determination is to be obtained from the relevant safety inspectorate.

# SECTION 1: Introduction

## 1.1 OVERVIEW & PURPOSE

NEX Building Group construct residential dwellings including single storey, two storey, duplex and terrace style homes for individual clients and developers. These homes are either timber or metal framed with brick or other style cladding. NEX Building Group operate in the Australian Capital Territory, New South Wales, Queensland, South Australia, Tasmania, Victoria.

The NEX Building Group (WHSEMP) describes the safety standards that governs work to be performed at NEX Building Group worksites. At each location, every practicable effort will be made to sustain the integrity of NEX Building Group's Work Health & Safety Policy in line with maintaining the Director's commitment to safety.

The WHSEMP includes matters of WHSE, emergency preparedness and response, incident management, the prevention, management and rehabilitation of injuries and illnesses, and specific hazards and risks associated with the work site.

## 1.2 LEGAL & OTHER REQUIREMENTS

The Work Health and Safety Acts, Regulations, Australian Standards, Codes of Practice or Compliance Codes and other requirements relevant to health and safety on any NEX Building Group Project have been identified and listed. These are available on request.

This document does NOT replace any Act or Regulations. All WHS Acts, Regulations, Standards and Codes of Practice having jurisdiction over work must be followed and adhered to. Non-adherence to these obligations may constitute a serious breach of the relevant WHS Act and your terms of engagement with us the PC.

Review of legislative requirements is completed monthly and reported to senior management and the board via the intranet, email and/or the WHS board report. Where legislative changes affect contractors and their workers, those changes will be communicated to those contractors via intranet, email, post, noticeboard, etc.

## SECTION 1: Introduction (continued)

### 1.3 DEVELOPMENT, REVIEW & COMMUNICATION OF WHSEMP

The WHS Act & Regulation in each respective region, details the obligations for PC to develop and make available a WHSEMP specific to each project.

Each person who is to carry out construction work in connection with a project, before commencing work, is made aware of the content of the WHSEMP and their right to inspect WHSEMP. Dependent on project size, the NEX Building Group may facilitate this via any or all of the following ways:

- A web link to WHSEMP;
- Hard copy on site;
- Email;
- By post on request;
- Hard copy in any local office;
- Letting meetings;
- Company inductions;
- Site specific inductions.

WHSEMP will be reviewed and updated as necessary to ensure it remains up to date. Review of WHSEMP may be conducted in response to an incident, on request of a client, when site circumstances require, or at maximum intervals of 2 yearly. To ensure each person carrying out construction work is made aware of and revisions to WHSEMP, The NEX Building Group may advise their stakeholders via any or all of the following:

- Face-to-face;
- Email, post or fax;
- Phone call or text message;
- Toolbox talks;
- Pre-start meetings;
- WHS Noticeboards;
- Company inductions;
- Site specific inductions.

A copy of WHSEMP will be kept until the project is finished, or in the case of a notifiable incident, 5 years from the time of the incident. A copy of WHSEMP will be readily accessible to any person who carries out construction work in connection with the project.

# SECTION 2: WHS & Environmental Policies

(continued)

## Work Health and Safety Policy

### OUR COMMITMENT

At NEX Building Group we are committed to pursuing the highest standards in our approach to preventing harm to all workers and other persons in the workplace by addressing health and safety risks arising from the work undertaken by the organisation. Thus, safety and sustainability are integral pillars of our mission.

### OUR OBJECTIVES

To demonstrate our commitment to providing a safe working environment by:

- a) Protecting workers and other persons from harm by eliminating or minimising risks.
- b) Providing for fair and effective representation, consultation and cooperation.
- c) Encouraging key stakeholders to take a constructive role in promoting improvements in health and safety practices.
- d) Providing health and safety advice, information, education and training.
- e) Ensuring the organisation employs processes to meet and maintain compliance with duties or obligations under the Work Health and Safety (WHS) Act.
- f) Establishing, monitoring and reviewing measurable targets aimed at eliminating work-related injury and illness.

### OUR RESPONSIBILITIES

Those with a leadership role are responsible for ensuring our objectives are met.

They will do this by:

- Ensuring compliance with all laws and regulations relevant to the workplace to protect the health, safety and wellbeing of workers and other persons.
- Playing a pivotal role in implementing this policy; driving health and safety performance, commitment and engagement.
- Maintaining and continuously improving their understanding of health and safety legislation.
- Promoting and fostering open lines of communication and consultation with workers.
- Understanding the nature of the organisation's operational hazards and risks.
- Exercising due diligence in health and safety decision-making.
- Ensuring health and safety is integrated into business planning and does not get devalued based on competing priorities, profit margins and lack of resources.
- Being accountable for the implementation and review of any change management processes.

- Meeting duty of care obligations as required under health and safety legislation.
- Ensuring appropriate resources are allocated to eliminate risks and achieve health and safety compliance.

### EMPLOYEES

Are responsible for ensuring they contribute to maintaining a safe and healthy work environment.

They do this by:

- Taking ownership of their own health and safety and those matters within their control or ability to influence.
- Working with others to promote health and safety practices and ensure it becomes part of everyday business.
- Working with leaders in the organisation to identify and address health and safety concerns in the workplace.
- Adhering to health and safety policies and procedures when performing work.
- Contributing positively to health and safety conversations by seeking information and sharing views.

### CONTRACTORS AND SUPPLIERS

Have a duty to take reasonable care for their own health and safety, and that the works and/or services performed do not adversely affect the health and safety of others.

In addition, this duty extends to complying, so far as they are reasonably able, with any reasonable instruction, policy or procedure which aids in health and safety compliance.

Failure to comply or observe a direction may be considered a breach of contract and sufficient grounds for termination.

### COMMUNICATION AND CONSULTATION

We are committed to communicating and consulting with all workers to provide opportunities to express opinions, ideas, and concerns.

This document will be reviewed at a minimum frequency of every 2 years to ensure its relevance to NEX Building Group operations.



Andrew Helmers  
Director  
NEX Building Group  
Feb 2024

# SECTION 2: WHS & Environmental Policies

(continued)

## Environmental & Sustainability Policy

### OUR COMMITMENT

At NEX Building Group we are committed to pursuing the highest standards in our approach to preventing pollution and promoting sustainability of the environment. We aim to review the environmental impacts of our business activities to proactively eliminate or reduce those impacts wherever possible. Thus, sustainability safety are integral pillars of our mission.

All those engaged by NEX Building Group who undertake work, accept that our environmental standards should not be compromised regardless of the situation and commit to protecting the environment as a priority.

NEX Building Group will consult with our clients, employees and other stakeholders in the development, implementation and continuous improvement of our environmental systems and seek partnerships with our trades, suppliers and contractors in reducing environmental impacts from our business activities.

### OUR OBJECTIVES

To demonstrate our commitment to protecting the environment by:

1. Proactively implementing NEX Building Group environmental policies & procedures.
2. Ensuring compliance with all local, state and federal laws and regulations.
3. Acting in a timely manner to address any environmental issues that are raised with us.
4. Consulting with our clients, employees, suppliers and contractors to ensure communication and consultation on environmental issues.
5. Ensuring employees and contractors receive appropriate information and training to raise awareness and improve management of the potential environmental impacts from business activities.
6. Ensuring where possible that NEX Building Group contracts entered into outline environmental & sustainability requirements, in order to relay the individual site requirements to our employees and contractors.
7. Striving to continuously improve NEX Building Group environmental & sustainability performance.

### OUR RESPONSIBILITIES

NEX Building Group acknowledges the close relationship it has with its clients and contractors. We will actively work with them to pursue a commitment towards meeting and maintaining the highest standards of environmental protection and sustainability.

### EMPLOYEES, CONTRACTORS, AND SUPPLIERS

All NEX Building Group managers and supervisors have a responsibility to be proactive and eliminate or reduce where possible any impact on the environment.

To achieve our goal, all employees, contractors, and suppliers who undertake work under the NEX Building Group banner will:

- Work diligently to ensure the elimination or reduction of adverse environmental impacts.
- Proactively promote recycling of materials and minimisation of waste.
- Actively participate in raising awareness of issues that may affect our environment so that these can be addressed.
- Ensure that any environmental issues encountered are reported to the responsible person on site.
- Co-operate with management in the implementation of environmental policies and procedures, including corrective actions if required.

This policy will be reviewed at least every 2 years to ensure its ongoing relevance to NEX Building Group operations.



Andrew Helmers  
Director  
NEX Building Group  
Feb 2024

## SECTION 3: Business & Project Organisational Chart

Below is a basic overview of the NEX Building Group reporting structure.

**Multi-residential projects** - will be covered in specific detail for each project in Part A.

**Domestic residential homes** - will be covered by SSSP.

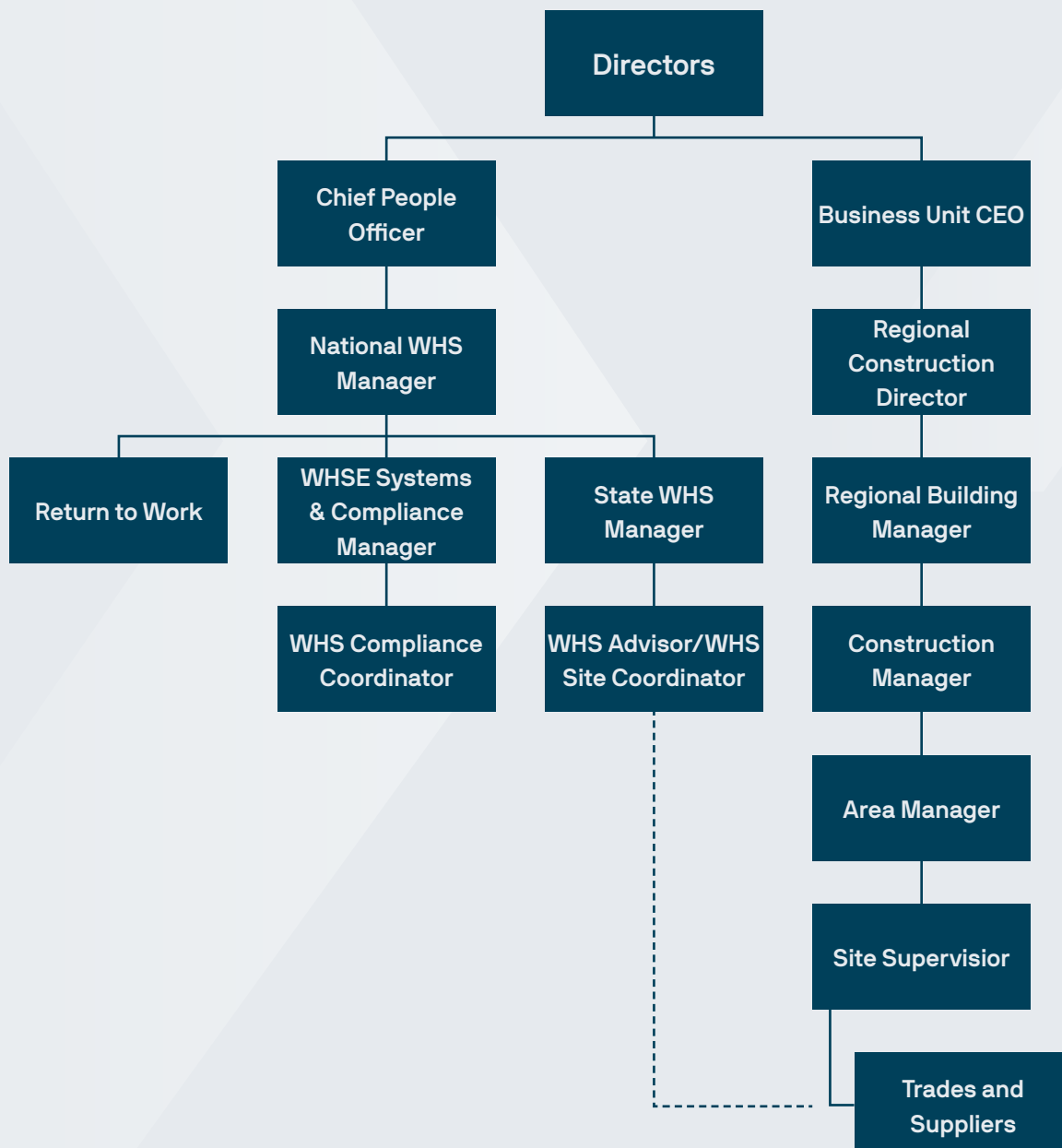

## SECTION 4: Responsibilities

### 4.1 DIRECTOR (PCBU & OFFICER)

The directors have duty under the WHS Act to take reasonable steps:

- a) To protect workers and other persons against harm to their health, safety and welfare through the elimination or minimisation of risks arising from work their business practices;
- b) To define and agree the business WHS policies and objectives and review work health and safety performance on a regular basis to meet WHS legal objectives;
- c) To acquire and keep up-to-date knowledge of work health and safety matters;
- d) To gain an understanding of the nature of the business and generally of the hazards and risks associated with those operations;
- e) To ensure that appropriate resources and processes are in place to eliminate or minimise risks to health and safety from work carried out by the business;
- f) To ensure that the business has appropriate processes for receiving information regarding incidents, hazards and risks, and responding in a timely way to that information;
- g) To ensure that the business has, and implements processes for complying with any duty or obligation under the Act
- h) To ensure the verification of the provision and use of the resources and processes referred to in paragraphs (c) – (g)

### 4.2 CHIEF EXECUTIVE OFFICER (OFFICER)

The Chief Executive Officer has a duty under the WHS Act to:

- a) Protect workers and other persons against harm to their health, safety and welfare through, elimination or minimisation of risks from work or from substances or plant as is reasonably practicable;
- b) Provide for fair and effective workplace representation, consultation, co-operation and issue resolution in relation to work health and safety matters;
- c) Where practicable encourage external organisations to take a constructive role in promoting improvements in work health and safety practices, by assisting persons conducting businesses or undertakings and workers to achieve a healthier and safer working environment;
- d) Promote the provision of advice, information, education and training in relation to work health and safety matters;



## SECTION 4: Responsibilities (continued)

- e) Effectively implement WHS Act compliance through fair and reasonable compliance enforcement measures across all relevant NEX Building Group business units;
- f) Ensure appropriate internal audit review of actions taken by persons exercising powers and performing duties under the Act;
- g) Provide a framework for measurable objectives & targets for continuous improvement for work health and safety;
- h) Review work health and safety performance on a regular basis to meet WHS legal objectives
- i) To acquire and keep up-to-date knowledge of work health and safety matters;
- j) To gain an understanding of the nature of the business and generally of the hazards and risks associated with those operations;
- k) To ensure that appropriate resources and processes are in place to eliminate or minimise risks to health and safety from work carried out by the business;
- l) To ensure that the business has appropriate processes for receiving information regarding incidents, hazards and risks, and responding in a timely way to that information;
- m) To ensure that the business has, and implements processes for complying with any duty or obligation under the Act
- n) To ensure the verification of the provision and use of the resources and processes referred to in paragraphs (i) – (n)

### 4.3 REGIONAL CONSTRUCTION DIRECTOR (OFFICER)

The responsibilities of the Regional Construction Director include but are not limited to, the following:

- a) Strive to maintain their knowledge and understanding of the current legislation and duties in the areas of environmental and work health and safety legislation, including their business WHSE management systems;
- b) Ensure compliance requirements to WHSE Standards are being implemented and managed in accordance with NEX Building Group system requirements;
- c) Provide guidance and motivation as required to achieve ecologically sustainable building practices;
- d) Provide adequate supervision at all levels to ensure the adoption of the business environmental, health and safety requirements;

## SECTION 4: Responsibilities (continued)

- e) Carry out regular reviews to check on WHSE compliance issues;
- f) Assist with compliance and enforcement matters on project site safety rules to meet both legal and business requirements;
- g) Review environmental, health and safety performance to address deficiencies of any member of the team who fails to meet business WHSE and Legal requirements;
- h) Ensure WHSE systems are established and pertinent information about, work, health, safety and environment is distributed to the relevant workers both internal & externally;
- i) Report to the CEO of the business unit on the level of compliance and standard of environmental, health and safety aspects and performance with regards to the business;
- j) To ensure relevant controls as identified in the Construction Risk Register are provided to ensure health and safety of personnel and others on site;
- k) Participate in site walkthroughs and suggest ways of eliminating hazards and improving environmental conditions & work health and safety on site;
- l) To acquire and keep up-to-date knowledge of work health and safety matters;
- m) To gain an understanding of the nature of the business and generally of the hazards and risks associated with those operations;
- n) To ensure that appropriate resources and processes are in place to eliminate or minimise risks to health and safety from work carried out by the business;
- o) To ensure that the business has appropriate processes for receiving information regarding incidents, hazards and risks, and responding in a timely way to that information;
- p) To ensure that the business has, and implements processes for complying with any duty or obligation under the Act
- q) To ensure the verification of the provision and use of the resources and processes referred to in paragraphs (l) – (p)

## SECTION 4: Responsibilities (continued)

### 4.4 REGIONAL BUILDING MANAGER (OFFICER)

The responsibilities of the Regional Building Manager include but are not limited to, the following:

- a) Assisting with the development and implementation of a SSSP for their projects;
- b) Strive to maintain their knowledge and understanding of the current legislation and duties in the areas of environmental and WHS legislation, including their business WHSEMP;
- c) Ensure compliance requirements to WHSE Standards are being implemented and managed in accordance with NEX Building Group system requirements;
- d) Provide guidance and motivation as required to achieve ecologically sustainable building practices;
- e) Provide adequate supervision at all levels to ensure the adoption of the business environmental, health and safety requirements;
- f) Carry out regular reviews to check on WHSE compliance issues;
- g) Work proactively with the Vendor Compliance Team to manage the suppliers & trades in line with the business expectations and standards;
- h) Assist with compliance and enforcement matters on project site safety rules to meet both legal and business requirements;
- i) Review environmental, health and safety performance to address deficiencies of any member of the team who fails to meet business WHSE and Legal requirements;
- j) Ensure WHSE systems are established and pertinent information about, work, health, safety and environment is distributed to the relevant workers both internal & externally;
- k) Report to the Regional Construction Manager of the business unit on the level of compliance and standard of environmental, health and safety aspects and performance with regards to the business;
- l) To ensure relevant controls as identified in the Construction Risk Register are provided to ensure health and safety of personnel and others on site;
- m) Participate in site walkthroughs and suggest ways of eliminating hazards and improving environmental conditions & work health and safety on site;
- n) Assist in coordinating, organising and attending regular construction meetings with Site Supervisors;
- o) Lead, manage and monitor site staff compliance with their Key Performance Indicators (KPI's);

## SECTION 4: Responsibilities (continued)

- p) Proactively report and investigate all accidents, incidents and near misses;
- q) To acquire and keep up-to-date knowledge of work health and safety matters;
- r) To gain an understanding of the nature of the business and generally of the hazards and risks associated with those operations;
- s) To ensure that appropriate resources and processes are in place to eliminate or minimise risks to health and safety from work carried out by the business;
- t) To ensure that the business has appropriate processes for receiving information regarding incidents, hazards and risks, and responding in a timely way to that information;
- u) To ensure that the business has, and implements processes for complying with any duty or obligation under the Act
- v) To ensure the verification of the provision and use of the resources and processes referred to in paragraphs (q) – (v)

### 4.5 CONSTRUCTION MANAGER

The responsibilities of the Construction Manager include but are not limited to the following:

- a) Assist in the development, implementation and review of the Site-Specific Safety Plans for their projects;
- b) Maintain knowledge and understanding of the current WHSE legislation and the WHSE management system, policies and procedures relevant for their role;
- c) Ensure WHSE Compliance of contractors and clients is achieved by engaging in the in-house contractor pre-qualification process facilitated by the Vendor Compliance Team;
- d) Liaise with Site Supervisor and the WHS Manager regarding any Client and/or subcontractor WHSE issue;
- e) Assist the Site Supervisor with compliance to WHSE Policies and Procedures, including the Site Rules on the project;
- f) Report all accidents, incidents and near misses to the business in line with company policy and procedures;

## SECTION 4: Responsibilities (continued)

### 4.6 AREA MANAGER

The responsibilities of the Area Manager include but are not limited to the following:

- a) Assist in the development, implementation and review of the Site-Specific Safety Plans for their projects;
- b) Maintain knowledge and understanding of the current WHSEMP, policies and procedures relevant for their role;
- c) Ensure Compliance of vendors is achieved by engaging in the in-house contractor pre-qualification process facilitated by the Vendor Compliance Team;
- d) Lead and manage the construction team on-site to perform their duties and meet KPI by:
  - Providing relevant information, instruction and training with the assistance of the WHS Manager;
  - Ensuring adequate supervision;
  - Providing adequate resources;
  - Ensure that On-Site Companion system is used to manage the project for workflow and vendor management;
- e) Liaise with Site Supervisor and the WHS Manager regarding any Client and/or subcontractor WHSE issue;
- f) Assist the Site Supervisor with compliance to WHSE Policies and Procedures, including the Site Rules on the project;

- g) Report all accidents, incidents and near misses to the business in line with company policy and procedures.

### 4.7 SITE SUPERVISOR (WORKER)

The responsibilities of the Site Supervisor include but are not limited to the following:

- a) Understand and abide by the business WHSEMP;
- b) Implement and review the SSSP for their projects, ensuring they are current and have been communicated with the relevant trades and suppliers for each project;
- c) Maintain knowledge and understanding of the current WHSE management system, policies and procedures relevant for their role;
- d) Ensure vendors understand the WHSE business requirements by completing the NEX Building Group induction;
- e) Ensure WHSE standards are being implemented and managed in accordance with the relevant Legislation and Standards;
- f) Work proactively with the Vendor Contractor Compliance Team to manage the suppliers & trades in line with the business expectations and standards;

## SECTION 4: Responsibilities (continued)

- g) Ensure subcontractor PCBUs are assessed on their environmental, health and safety prior to, during and after completion of the project i.e., ensure contractors abide by the site safety rules;
- h) Provide guidance and supervision as required to achieve these standards on site consistently;
- i) Assist with compliance and enforcement matters on project site safety rules to meet both legal and business requirements;
- j) Ensure PPE is used by contractors when required on site;
- k) Assume the role of Chair of the Project Safety Committee, and act as the WHS representative on site (if required);
- l) Attend regular construction meetings held by construction management;
- m) Assist in resolving any disputes that may arise over environmental, health or safety issues on site and subcontractor PCBU complaints;
- n) Report any subcontractor PCBU issues and any pertinent environmental, health and safety issue on site;
- o) Report all accidents, incidents and near misses to the business in line with company policy and procedures;
- p) Secure and preserve the scene of a notifiable incident site for investigation;
- q) Assist in the investigation of any incidents as directed;
- r) Oversee any site evacuations/emergencies (practice or otherwise) and document relevant outcomes;
- s) Ensure any control item, sign, barrier, guard, equipment, etc. is provided to ensure health and safety of personnel on site is not tampered with, modified or removed;
- t) Conduct regular and staged site inspections and suggest ways of eliminating hazards and improving environmental conditions & work health and safety on site;
- u) Monitor site safety compliance in accordance with the KPIs set for this role
- v) Ensure they have the appropriate first aid training and that the relevant equipment is available in the case that an injury should occur;
- w) Support the Return to Work (RTW) of injured workers, by assisting the RTW Coordinator;
- x) Be the key Client contact and liaison and ensure that Client contractual requirements such as Client reports are prepared and communicated.

## SECTION 4: Responsibilities (continued)

### 4.8 WORK HEALTH & SAFETY MANAGER

The responsibilities of WHS Manager include but not limited to, the following:

- a) Assist the Business in the development, implementation and co-ordination at every level of the SSSP;
- b) To be adequately qualified as per the position job description (Minimum Certificate IV WHS);
- c) Provide advice to Construction Team about the overall state of environmental compliance and work health and safety at the workplace; also advise of conditions that require a Safety Improvement/Non-compliance Notice to be issued to a PCBU subcontractor concerning WHSE issues;
- d) Support the Vendor Compliance Team, when requested;
- e) Conduct and record WHSE inspections and audits at the workplace to identify hazards and unsafe or unsatisfactory environmental, health and safety conditions and practices, and advise all levels of management of any deficiencies identified that may arise from time to time;
- f) Work with all levels of site management teams, to ensure a commitment to working safely and where appropriate provide guidance, motivation, information, instruction and resources which are required to achieve the environmental and safety goals and initiatives as outlined to workers on site;
- g) To establish appropriate educational programs in environmental, work health and safety including the site induction process for continuous improvement;
- h) To report, investigate, or assist in the analysis of all environmental harm, injuries, illnesses, incidents and notifiable events at the workplace. If any notifiable event occurs – to escalate and manage the investigation process & corrective actions to meet legal obligations;
- i) To assist Government Jurisdictional Inspectors in the performance of the Inspector's duties while at the workplace;
- j) To set up project recording mechanisms so that relevant environmental and safety information is properly compiled and easily accessible;
- k) To provide technical advice to the site team and PCBUs at all levels on environment, WHSE matters;

## SECTION 4: Responsibilities (continued)

- l) Participate in site walkthrough and suggest ways of eliminating hazards and improving environmental conditions & WHSE on site.

### 4.9 RETURN TO WORK COORDINATOR (EXTERNAL PROVIDER AON)

Assist injured workers to remain at or return to work as soon as safely possible after injury by:

- a) Compiling the initial notification information;
- b) Coordinating the worker’s recovery at work, including identifying suitable work;
- c) Preparing, monitoring and reviewing a worker’s recover at work plan;
- d) Liaising with the worker’s support team;
- e) Supporting the redeployment of workers (internally or externally) into suitable work when they cannot return to their pre-injury duties;
- f) Keeping confidential case notes and records in line with laws and guidelines;
- g) Implementing the RTW program;
- h) Keeping injury and recover at work statistics;
- i) Promoting the health benefits of good work;
- j) Contributing to the improvement of relevant policies and systems.

### 4.10 WHS ADVISOR/WHS SITE COORDINATOR (WORKER)

The responsibilities of WHS Advisor/WHS Site Coordinator include but are not limited to ensuring:

- a) The health and safety matters of the workers are represented;
- b) Information about health and safety issues is gathered for their work group;
- c) WHS incidents are recorded and reported in line with business requirements;
- d) WHSE issues are reported to the WHS Manager;
- e) The issue resolution process is actioned in consultation with PCBU representatives;
- f) Where the HSR has completed the approved training, they can direct a worker to stop unsafe work, and issue a provisional improvement notice if they reasonably believe there is a contravention of the Act;
- g) Participate in site walkthrough and suggest ways of eliminating hazards and improving environmental conditions & work health and safety on site;
- h) Supporting the Vendor Compliance Team, when requested.



## SECTION 4: Responsibilities (continued)

### 4.11 EMPLOYEE (WORKER)

Employees have an obligation under the WHS Act to ensure that they work in a safe manner and co-operate with their employer, employee representatives and any other person associated with the WHS legislation. The responsibilities include:

- a) Comply with any site induction training requirements;
- b) Work in a safe manner which does not place themselves, other workers or any members of the public at risk;
- c) Use any equipment supplied by the business according to the manufacturer's specifications;
- d) Follow instructions from their manager and comply with the site safety rules;
- e) Report all incidents, accidents and near misses to construction management;
- f) If injured at work, they are to participate actively in a return-to-work program recommended by their doctor and rehabilitation provider where required.
- b) Comply with the site safety rules and safety requirements;
- c) Ensure all workers, engaged by the contractor, and attending site, hold a general construction induction card (white/blue/red card) before allowing or directing them to attend site;
- d) Ensure they and their workers are trained in the relevant work activity they are proposing to engage in;
- e) Ensure they and their trades have the relevant PPE when required;
- f) Comply with any site induction training requirements;
- g) Ensure all equipment brought onto sites is maintained in a safe working order and is operated in accordance with the manufacturer's specifications;
- h) Report all accidents, incidents and near misses to the Site Supervisor immediately and ensure that the appropriate forms are completed;
- i) Ensure that they have the relevant sized first aid kit available and fully stocked ready for use when required;
- j) Ensure a register of injuries is kept of all persons receiving first aid treatment;
- k) Assist persons injured at work, by encouraging their early return to work through return-to-work programs and rehabilitation.

### 4.12 CONTRACTOR (PCBU & WORKER)

The responsibilities of contractors include but are not limited to the following:

- a) Comply with WHSEMP;

## SECTION 4: Responsibilities (continued)

### 4.13 FIRST AID OFFICER

The responsibilities of the First Aid Officer within the business include but are not limited to the following:

- a) To possess a current certification to Apply First Aid & Cardiopulmonary Resuscitation (CPR);
  - b) Ensure and maintain the adequacy and suitability of first aid provisions for the workplace provided by the business;
  - c) Replenish the first aid kit, after an incident or use on site, ready for any further events;
  - d) Undertake regular inspections of the first aid kits and keep a record of the process.
- Note:** All NEX Building Group Site Supervisors are first aid & CPR trained.
- b) Support the Vendor Compliance Team to ensure that vendors are compliant before signing contracts for the supply of materials goods and services;
  - c) Ensuring relevant checklists are used for qualifying Suppliers & Sub-contractor tenders;
  - d) Ensuring scopes of work for individual tasks include the obligation on suppliers whom deliver to site to meet their safety and regulatory aspects (i.e., Chain of Responsibility);
  - e) Ensuring company inductions for Suppliers & Sub-contractor trades are undertaken to ensure compliance with minimum standards;
  - f) Assisting in monitoring contractor responses & follow-up outstanding documentation from the contractors.

### 4.14 PURCHASING/PROCUREMENT TEAM

The responsibilities of Purchasing/ Procurement Team within our business includes but is not limited to the following:

- a) Ensuring that that all materials, equipment and plant purchased or hired conforms to the relevant WHS legislation and Australian Standards;

Where a specific role is not allocated to a project, the responsibilities will be delegated to the next superior role.

## SECTION 5: Objectives & Targets

NEX Building Group will establish, implement and maintain documented WHSE objectives and targets, for each relevant function and level within the organisation and take into consideration the legal and other requirements, the WHSE hazards and risks, the operational and business requirements, and the views of interested parties. The objectives and targets shall be consistent with the WHS policy, including the commitment to measuring and improving WHSE performance.

The organisation's top management shall appoint a specific management representative(s) who, irrespective of other responsibilities, shall have defined roles, responsibilities and authority for:

- Ensuring that the WHSEMP requirements are established, implemented and maintained in accordance with the WHSEMP.
- Reporting on the performance of these target & objectives to senior management for review and as a basis for continuous improvement.

## SECTION 6: Design

The NEX Building Group apply the safety in design principles to the design of our homes, and the management of safety on site throughout the construction phase, through to handover and maintenance of the home by the customer. Where the construction has been designed by NEX Building Group, we will ensure that:

- Wherever practicable, the building design and construction is safe and that all safety requirements for construction and maintenance have been assessed;
  - Any hazards or risks identified within the design phase are documented and communicated to the respective parties;
  - A review of the risks is completed to eliminate or reduce any identified risk to an acceptable level;
  - Identified risks are recorded on a risk register along with any corrective actions taken and controls implemented;
  - All stages of the design and construction process are reviewed;
  - Any changes in the construction build process by the client or business unit are reviewed;
- The right is reserved to change any stage of design if there is the opportunity to improve construction safety procedures if the safety procedures in place are deemed to be inadequate.

Where the construction has been designed by an external party, the designer of the structure or any part of the structure that is to be constructed must give NEX Building Group a written report that specifies the hazards relating to the design of the structure that, so far as the designer is reasonably aware:

- Create a risk to the health or safety of persons who are to carry out any construction work on the structure or part;
- Are associated only with the particular design and not with other designs of the same type of structure.

## SECTION 6: Design (continued)

Some of the other ways in which safety in design principles are used include NEX Building Groups own in-house processes and the use of consultants including but not limited to:

### DOMESTIC RESIDENTIAL HOMES:

Assessment of site through a 'Pre-Tender Site Specific Risk Assessment' which occurs prior to acceptance of contract with customer.

Part 1 of this process takes into account the following:

- Any existing structures;
- Site access including the levels and natural fall of the block;
- Delivery requirements including craneage;
- Traffic control;
- Environmental controls;
- Distance to neighbouring properties;
- Location of overhead and/or underground power;
- Site location including proximity to traffic lights, busy intersections, roundabouts etc;
- Further assessment of site through parts 2 & 3 of the 'Pre-Tender Site Specific Risk Assessment' which occurs prior to the Estimating stage. This is a second look at the site to confirm the 'Pre-Tender Site Specific Risk Assessment – Part 1' findings.

### MULTI RESIDENTIAL PROJECTS:

Completion of a site assessment resulting in the creation of a project specific 'HIRAC' risk register which is reviewed throughout the construction phase where updated required.

### ALL CONSTRUCTION

- Product safety managed through the Procurement Manager, with all NEX Building Group supplied product classified as a Hazardous Chemical/Substance to be accompanied by a SDS which is provided to the end user;
- Geotechnical soil reports completed on each site to test the structure of the soil, which is used to identify what type of foundations and slab are required;
- Joist layout, material selection (steel, timber or combination of both), and frame and truss design certified by a structural engineer through our suppliers;
- Before You Dig Australia searches;
- Electrical design consultants to design the electrical layout within the house;
- Hydraulic engineers to design the water management and retention, and sewage requirements of the site;
- Acoustic engineers are engaged to provide advice on controls surrounding sound requirements for things such as air-conditioning systems, window glazing etc;

## SECTION 6: Design (continued)

- Fall protection systems are provided for construction works where workers may be required to work at a height of 2 metres or more above the ground;
- Trained, qualified and approved tradesmen are used to construct the design;
- All products and construction methods are in accordance with Australian Standards and the National Construction Code/ Building Code of Australia;
- Where a client makes a variation to a standard design which may involve further safety control consideration, NEX Building Group will provide the client with guidance on how to safely maintain that product once construction is complete.

# SECTION 7: Performance Reporting

## REPORTING REQUIREMENTS

NEX Building Group strive to achieve project wide performance reporting through the following key strategic activities:

- Documented site inspections
- Documented site audits
- Board reports
- Toolbox Talks
- Construction Team Meetings
- Client Meetings
- Committee Meetings
- NEX Building Group General Managers Meetings
- NEX Building Group Board of Directors Meetings

## SECTION 8: Communication & Consultation

NEX Building Group welcomes all stakeholders to actively raise and discuss any health and safety or design issues with the WHS Manager, WHS Representative or Site Supervisor. Stakeholders are encouraged to take an active part in health and safety matters in order to communicate and consult on safety issues.

Consultation will be undertaken with all relevant stakeholders who may be affected by a health and safety risk on site to ensure the following:

- Information is shared;
- Stakeholders are given reasonable opportunity to express their views and raise issues;
- Stakeholders are given reasonable opportunity to contribute to the decision-making process;
- Views of the stakeholders are considered, and they are advised on the outcomes of any consultation.

Consultation may be done in one or more of the following ways:

- Face-to-face;
- Microsoft teams;
- Email, post or fax;
- Phone call or text message;

- Toolbox Talks;
- Pre-start meetings;
- Safety alerts;
- WHS Noticeboards;
- Committee meetings;
- Company inductions;
- Site specific inductions;
- Trade letting meetings.

Where PCBUs conduct an activity, that may have an effect on the health or safety of others, PCBUs are required to cooperate and coordinate such activities with each other.

Where more than one PCBU owes a duty over the same matter, PCBUs may decide to cooperate and coordinate with just one documented procedure. This may include appropriate hazard/risk assessments and mutual arrangements put in place with respective controls.

The Site Supervisor is the WHS Representative for their site. Where the project size deems it required, a designated HSR may be appointed. Where it has been requested by 5 or more people, a health and safety committee will be elected.



## SECTION 9: Training & Competency

A “duty of care” responsibility is required by all involved in the construction process. This will require the necessary training of all personnel to ensure they have the required skills to work safely. NEX Building Group are committed to ensuring the highest standards in WHSE training is provided. Training provided to internal staff is recorded on a training register and copies of certificates and qualifications are stored in individual personnel files. Training records for contractors are stored electronically.

### 9.1 CONSTRUCTION GENERAL INDUCTION

All persons who work on NEX Building Group construction sites must undertake ‘CPCCWHS1001 Work safely in the construction industry’ (or its earlier equivalent) prior to commencing work on-site and must have the card available for inspection by NEX Building Group staff or the relevant State Regulator.

### 9.2 INTERNAL STAFF

Management/ Supervisor Safety Induction

All staff in construction supervisory positions will be provided the following training within a maximum of 3 months from commencement with NEX Building Group:

- NEX Building Group Company Induction Training;
- NEX Building Group General WHS Induction Training;
- NEX Building Group WHSE Management Systems (Multi Only);
- NEX Building Group WHSE WHSEMP;
- Software systems i.e., Onsite Companion/ Evolve, GoCanvas reporting systems;
- Relevant Workplace Safety Legislation, Regulations and Codes of Practice;
- First Aid & CPR Training;
- Emergency Warden Training where required;
- Asbestos and Silica Awareness training for workers in the ACT.

## SECTION 9: Training & Competency (continued)

### 9.3 CONTRACTORS, SUB-CONTRACTORS & THEIR WORKERS

#### NEX BUILDING GROUP WHSE CONTRACTOR INDUCTION

All persons who work on NEX Building Group sites must complete the NEX Building Group WHSE Contractor Induction. The NEX Building Group induction has a 2 yearly completion requirement. On completion of the induction, the inductee will receive electronic proof of induction. The worker must have proof of induction available for inspection by NEX Building Group staff or the relevant State Regulator.

#### SITE SPECIFIC INDUCTION

Supplementary to the NEX Building Group WHSE Contractor Induction, a Site-Specific Induction will also be provided. Dependent on the size of the project, the delivery of site-specific information will be facilitated in 2 ways. For sites that contain individual houses, site specific information will be provided to the worker via the SSSP which is provided to the contracting business with the purchase order(s). Any other site-specific hazards may also be included on the site safety signage on site. The SSSP may contain the following information:

- Site details/job#/DA/CC#/address;
- Site-specific hazards identified & controls required to deliver materials & build safely;
- Key internal & external contacts responsible for construction safety ;
- Emergency service contact numbers;
- Local medical centre contact details and address.

On multi residential projects where there is a static Site Supervisory Team, Site Specific Induction will be provided prior to commencing works at that site. The following types of information are provided at induction:

- The expectations outlined in the WHSEMP;
- Policies and procedures;
- The site emergency procedures and evacuation muster point;
- The site rules;
- The facilities;
- Any site-specific hazards.

Any further information regarding hazards that change throughout construction will be communicated as per Section 8 of this document.

## SECTION 9: Training & Competency (continued)

### OTHER TRAINING

Contractors/subcontractors are also responsible for ensuring that the following training is provided to their workers:

- Use and maintenance of each item of PPE require for use in their work;
- Contractor Trade Licensing where required;
- High-Risk Work Licensing where required and/or proof of competency for load shifting machinery;
- Task specific training through Safe Work Methods, Safe Operating Procedures, Safe Work Instructions and the like;
- Safe use of power tools;
- Safe use of hazardous chemicals/ substances as per the relevant SDS;
- Fatigue management;
- Sun/UV/working in heat safety;
- Completing Site Specific Risk Assessments/ Job Safety Analysis;
- Employee induction into the employer's own systems;
- Ongoing training through toolbox talks or pre-start meetings regarding safety issues;
- Any other training as deemed necessary to ensure the worker is competent to perform the required task.

# SECTION 10: On-Site Management of Hazards and Risks (Site Rules)

NEX Building Group is committed to building quality construction projects safely. People are our most important asset and their health and safety is our greatest responsibility. The public shall be given equal priority to that of our Employees and Contractors (Workers). The following site safety requirements have been developed for the safety of all.

## 10.1 SITE SECURITY

There will be no security measures in place on any construction site apart from site fencing; therefore, all persons who work on a NEX Building Group sites are responsible for their own equipment. NEX Building Group will not take any responsibility for any equipment that is left unattended or unsecured on their construction sites. Workers must secure the site e.g., lock doors or replace site security perimeter fencing after completion of work.

## 10.2 SITE ENTRY AND PARKING

General access to construction sites must be established in a safe manner, with no potential of endangering workers working on the site, or any members of the public.

## 10.3 GENERAL ACCESS & EGRESS

Adequate safe access & egress on site will be managed by:

- Coordinating the deliveries & trade work activities;
- Suppliers and contract delivery companies ensuring safe placement of loads;
- Access & egress also includes the public footpath & neighbouring sites. Construction teams may need to communicate & consult with the neighbour or builder in the adjoining site to achieve safety in on or around the construction project /site;
- When communicating with others regarding shared security measures on site, the Site Supervisor must record the communication either via email, site diary, text message etc., and where necessary take site photographs.

## 10.4 CONSTRUCTION SITE FENCING

- Where the fence is altered or dismantled for access or the like, it must be re-instated by whomever altered it immediately following access;

## SECTION 10: On-Site Management of Hazards and Risks (Site Rules) (continued)

- In the instance that fencing panels are removed, they must be laid flat on the ground and not supported by the other sections of fencing for safety reasons – i.e., crush hazard from falling objects;
- Gates should remain closed wherever possible to prevent unauthorised access, and not left open blocking footpaths or roadways;
- Any unauthorised entry to sites must be reported to the Site Supervisor;
- At the end of each day, the construction site must be left in a safe and secure manner;
- Non-compliance notices and where required back charges may apply to contractors to rectify the fencing.

### 10.5 SITE SAFETY SIGNAGE

Before construction work starts, NEX Building Group will ensure that the relevant safety signs, having regard to the size and complexity of the workplace, are erected, and maintained throughout the construction. Appropriate signage may include the following:

- The nature of the workplace;
- The direction to the site office or site amenities;
- The principal contractors details

- Where first aid and fire extinguishing equipment are kept;
- The means of access are to be kept clear;
- Where hazardous substances are kept;
- An emergency 24hr contact number;
- Relevant PPE to be worn;
- Authorisations required for the site.

No person is to remove, replace, destruct, move or impair the view of any signage on NEX Building Group construction sites without permission from the Site Supervisor. If a sign is tampered with in any way, the Site Supervisor should be notified immediately.

### 10.6 SITE VISITORS

- Any visitor to site must obtain permission from NEX Building Group beforehand, and suitable arrangements must be made for them to be accompanied to site by a NEX Building Group representative;
- Visitors must be under the supervision of Site Supervisor or other NEX Building Group representative and must comply with all site safety instructions and rules;
- Suitable footwear must be worn at all times on site (no open shoes or thongs);
- Safety helmets/hard hats must be worn on site in areas nominated as hard hat zones by the Site Supervisor, and in particular where:

## SECTION 10: On-Site Management of Hazards and Risks (Site Rules) (continued)

- Any person entering an area where there is a risk of falling objects;
- Any chance of persons being struck by or striking an object.

### 10.7 SITE SPECIFIC RISK ASSESSMENT (SSRA)

All contractors must apply a duty of care and accountability by carrying out a written SSRA or Pre-Start Check of the workplace, prior to undertaking work on site, to identify any hazards that may affect safety on site, and where necessary, arrange for the appropriate control measures to be put in place. If serious risks are still present, the worker must contact the Site Supervisor/NEX Building Group to inform them what the issues are and await instructions.

Site Supervisors & Internal/External Auditors may ask to see the SSRA. Failure to complete an SSRA may result in a Non-Compliance Notice being issued, or the contractor may be asked to leave the site.

### 10.8 WHS ISSUE RESOLUTION

Where a WHSE issue has been identified, attempts to resolve the issue will be facilitated by:

- Reporting the problem to the Site Supervisor or WHSE representative;
- Where the issue cannot be resolved immediately, further advice will be obtained from the WHS Manager or other senior management;
- If the issue still remains unresolved, it will be referred to the WHS Committee;
- Where the committee cannot resolve the issue, they will refer to the state safety regulator to request an inspector to attend the workplace and resolve the issue. The inspector's decision will be final and binding.

### 10.9 SITE CLEANLINESS (HOUSEKEEPING)

An unclean site is a dangerous site. Waste generated must be cleaned up progressively; so as not to cause a hazard (minimum requirement is daily). Workers should remove their waste from site and dispose of it. There are allocated waste disposal enclosures/bins on site for approved waste only. Food waste must not be disposed of on site. Equipment or materials must never be left on the footpath or other public property.

# SECTION 10: On-Site Management of Hazards and Risks (Site Rules) (continued)

## 10.10 AMENITIES

### TOILETS

- Separate male and female toilets will be provided (where required);
- Where workforce includes females, provisions should be made of the adequate and hygienic disposal of sanitary items;
- Hand washing facilities are provided in, or adjacent to, each toilet facility;
- One toilet will be provided for every 15 workers (or part thereof);
- All toilets will be cleaned and maintained on a regular basis.

### WATER

Where reticulated water is available it will be made accessible for workers and trade contractors. Otherwise, portable water should be taken to site.

### MEAL ROOM

The building under construction may be used for meals or workers may use their vehicles. Dependent on the size of the project, meal rooms may be provided. Workers must ensure all food waste is removed and disposed of at the end of each day.

## 10.11 PERSONAL PROTECTIVE EQUIPMENT

PPE used on site must comply with the appropriate Australian Standard, used as per manufacturer’s instructions, and must be in good condition for the intended use. When required, all workers must wear the necessary PPE to conform to the requirements of their SWMS for the task to be undertaken and any relevant SDS for chemicals used.



### SAFETY FOOTWEAR:

Enclosed safety footwear with steel toe caps and suitable tread shall be worn at all times on site. Bare feet, thongs, flimsy or unsuitable footwear is prohibited. The type of footwear worn must be identified in the task specific safe work method statement.



### HARD HATS/SAFETY HELMETS:

Safety helmets must be worn on site in areas nominated as ‘hard hat zones’ by the Site Supervisor and in particular where:

- Any person is working, or situated below another person;
- Is a chance of any person(s) being struck by, or striking an object.

## SECTION 10: On-Site Management of Hazards and Risks (Site Rules) (continued)



### **EYE PROTECTION:**

Eye protection is to be worn when in designated areas or when drilling above, or in any other situation where there is risk of injury to the eyes, such as grinding, cutting etc.



### **HEARING PROTECTION:**

Hearing protection in the form of ear plugs or earmuffs is to be worn when operating drills, cutting metal or in any other situation where the noise level is excessive. Working near or around noise can damage your hearing, even if you are not using a noise generating tool.



### **RESPIRATORY PROTECTION:**

Respiratory protection is to be used when generating dust (for example blowing down, sanding, cutting or when using chemicals and/or it is recommended by the supplier). Dry cutting of products containing crystalline silica is banned.



### **HAND PROTECTION:**

Gloves should be worn when there is any chance of injuring hands, whether by cuts, abrasions, crushing or burns. The appropriate gloves are also to be worn



when working with hazardous substances, and as recommended by the supplier or as directed by the SDS.

### **HIGH-VISIBILITY CLOTHING:**

High-visibility (hi vis) clothing must be worn when working near mobile plant, or as deemed appropriate by the site management or specified by the site rules.



# SECTION 10: On-Site Management of Hazards and Risks (Site Rules) (continued)

## 10.12 TRAFFIC MANAGEMENT

Traffic and pedestrian management requirements will be identified, and relevant resources allocated where required to ensure adequate traffic/pedestrian management plans are put in place. The information should be communicated to all persons attending the site, this could also include neighbouring premises. If it is identified that a high-level traffic management plan is required, this should be drawn up by a suitably qualified person and then communicated to enable a safe process of deliveries to site; especially clear way zones.

Everyone must ensure they have an understanding and awareness of basic traffic control requirements, to ensure the safety of anyone when arriving at a construction site. Traffic Management should address the following site safety traffic aspects:

- Arriving at site entry and exit points;
- Parking on the roadways;
- Parking on site;
- Unloading vehicles;
- Parking on the median strip;
- Pedestrian access;
- Parking over public/pedestrian foot paths.

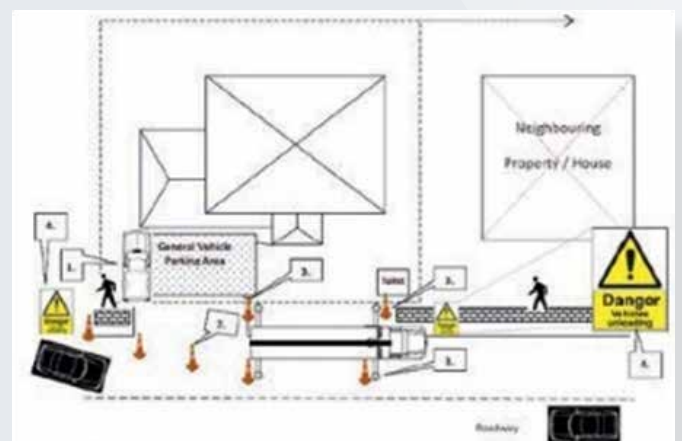

Figure 1

An example of traffic management is shown in Figure 1 and details the following:

- Trades person's 'ute' (trailer etc.) does not require traffic management as the vehicle is parked off the road in a safe position;
- A minimum of four traffic cones are required to provide a visual aid to both the oncoming traffic and traffic in the lane of passage to prevent the risk of an incident;
- Additional traffic cones are required to raise awareness of additional hazards of the stabiliser protruding into both the roadway and over the pedestrian footpath. Suitable indicator flags or flashing warning lights may also be used to highlight these potential hazards;

## SECTION 10: On-Site Management of Hazards and Risks (Site Rules) (continued)

- Safety signage should also be used to inform the public of potential hazards near the work activity.

### **OTHER CONTROLS TO BE FOLLOWED:**

- A work activity/task and SSRA must be completed by contractors prior to commencing work;
- Where Traffic Management Plans are in place they must be followed, including that all workers to keep at least 3 metres away from any forklift or other item of mobile plant that is in use;
- Workers must communicate including ensuring verbal and eye contact between themselves and the plant operator if plant is operating nearby;
- Travel speed on site must be within 10 km/hr limit always;
- All workers must follow Traffic Management rules and not walk through barricaded areas;
- When unsure about any traffic management requirements, workers must contact the Site Supervisor for advice.

### **10.13 ASBESTOS**

If a construction site has been a previous knock down and rebuild, NEX Building Group will ensure a NATA certified site hygiene clearance certificate has been obtained before proceeding, and a copy placed on the job file before starting the proposed construction.

If unforeseen Asbestos Containing Material (ACM) is detected during construction, NEX Building Group will stop work and secure the area/site with fencing or barricade from further access or disturbance. All work in that area will be halted until further notice.

Appropriate danger signage will be posted to indicate asbestos area of danger (such as – ‘Danger Asbestos’).

Where contractors identify asbestos on site, they must immediately contact their Site Supervisor to seek advice on further corrective actions, such as; remediation to eliminate the risks of exposure.

An arrangement for a licensed removalist to undertake remediation work and authorised disposal of asbestos should take place as soon as possible.

## SECTION 10: On-Site Management of Hazards and Risks (Site Rules) (continued)

Once removal is complete NEX Building Group will obtain a site hygiene clearance certificate from a NATA accredited person prior to recommencing work, and keep a copy on file.

### 10.14 CRYSTALLINE SILICA

Crystalline silica is a naturally occurring mineral found in most rocks, sand, clay. It is used in manufacturing building products and construction materials such as bricks, concrete, tile and composite stone used to fabricate kitchen benches and countertops. Workers can also come across crystalline silica when undertaking construction works that require excavation or tunnelling through quartz containing rocks such as shale and sandstone.

Applying adequate controls such as controlling the generation of airborne dust can reduce hazardous exposures and prevent illness in the workplace. When working with products that contain crystalline silica the following controls must be followed:

- Eliminate tasks that generate dust where possible;
- Apply water suppression systems to reduce dust generation;
- Use local exhaust ventilation systems to capture and remove dust at the source;

- Use dust capture systems on portable tools;
- Use well maintained and appropriate personal protective equipment (e.g. – respirators);
- Instruct and train workers in the correct fitting, use and maintenance of respirators;
- Avoid using compressed air to remove or clean settled dust;
- Follow instructions and controls outlined in safety data sheets and product labels;
- Dry cutting is banned on all NEX Building Group sites.

For further information refer to NEX-Silica Fact Sheet available on the NEX Vendor Hub.

### 10.15 UNDERGROUND ESSENTIAL SERVICES/UTILITIES (GAS, WATER, ELECTRICITY, SEWER AND COMMS.)

Before You Dig Australia (BYDA) – previously called Dial Before You Dig is the law. The information must be considered in planning the work and deciding on and using control measures to prevent people being exposed to the risk of death, illness or injury from coming in to contact with, or damage to, the service.

## SECTION 10: On-Site Management of Hazards and Risks (Site Rules) (continued)

Before excavation work starts, the NEX Building Group and the respective PCBU's must ensure the following:

- Find out what underground services exist at or near the location of the excavation;
- Obtain relevant information about the service (location, type, depth, restrictions to be followed) from the appropriate source i.e. BYDA search;
- Obtain information from the owner of the site about any buried cables;
- Identify and mark existing services;
- Disconnect services where appropriate and obtain written confirmation of such;
- Where services will remain in place, potholing by hand digging with non-conductive tools must be completed within 1 metre of those identified services or otherwise located using underground locators;
- Record the information in writing & on file;
- Keep the information recorded until the construction work ends.

### 10.16 WORKING NEAR UNDERGROUND ELECTRIC LINES

All underground electric lines on site should be considered live unless specifically tested by an electrician in the presence of the person working in the vicinity. The

underground power diagram located on the underside of the meter box lid must be inspected and understood by any worker intending to break the ground, to ensure safety of the workers on site. If there is no underground power plan in the meter box, no excavation is to take place before consulting the Site Supervisor.

The best way to eliminate the hazard is by preventing people, plant, equipment and materials from coming close enough to energised underground electric cables for direct contact or arcing to occur.

The following are considerations when choosing appropriate controls:

- De-energising the electricity supply, or;
- Isolating the electricity supply for the duration of the work;
- Where elimination is not reasonably practicable, minimise the risks by substituting the hazardous work practice with something safer for example by:
  - Using insulated hand tools;
  - Using non-powered hand tools, or;
  - Hiring a person with relevant electrical qualifications to do the job.

## SECTION 10: On-Site Management of Hazards and Risks (Site Rules) (continued)

– Consider isolating the hazard from people by installing a physical barrier to prevent accidental contact between the hand-held tool and underground electric cable. If a risk remains, consider the following controls in the order below as administrative controls like:

- Authorisation to do the work (for example, a permit to work);
- Training workers to identify hazards and perform the work safely;
- Suitable PPE, such as:
  - Insulated gloves;
  - Rubber soled boots, & safety helmets.

A combination of the above controls can be used if a single control is not enough to minimise the risks.

### 10.17 WORKING NEAR OVERHEAD ELECTRIC LINES

Contact with energised electrical lines can cause death, electric shock or other injuries. An electric shock can also occur without direct contact with power lines.

Work is not permitted within Electrical No Go Zones without consulting with the relevant state electrical supply authority and in most cases, obtaining a permit or other formal instruction from that supply authority, prior to works commencing

The permit or other formal instruction will outline the steps and conditions required to undertake the task safely. If you cannot comply with the No Go Zone safety procedures, then no work must be undertaken without specific permission from the relevant electrical supply authority.

If site conditions change then work must stop, and further consultation will be required to ensure that the appropriate controls are applied and any further permits or instruction from the supply authority is obtained.

Some construction work activities that may require work near overhead electrical lines include (but are not limited to):

- Scaffolding systems;
- Roofing works;
- Guardrail systems;
- Metal frames, metal battens and purlins;
- Metal guttering, fascia or pipes etc;
- Concrete placement boom pumps;
- Load shifting machines (for example – excavators);
- Cranes including vehicle loading cranes;
- Truck and tipper and delivery of materials;
- Trucks unloading and loading plant.

## SECTION 10: On-Site Management of Hazards and Risks (Site Rules) (continued)

When assessing the risks consider:

- The location, height, arrangement and visibility of overhead electric lines and supporting structures (for example, poles, towers, and stay wires);
- The voltage of electric lines and exposed energised parts and whether they are insulated or bare;
- Possible sway or sag of the electric lines;
- Environmental conditions (for example, storm activity, heavy rain, hail and lightning);
- Site conditions (for example, wind strength and direction, terrain, ground surface and vehicular traffic);
- Type of plant and machinery required – design envelope, stability, dimensions and operating characteristics, minimum clearance distances and manoeuvrability;
- The nature, size and shape of loads to be moved (for example, load stability, whether loads are conductive and how loads are secured);
- The type of work activities required and the frequency of work tasks;
- Qualifications, competency, skill and experience of people doing the work;
- The setting up and packing up processes;

- Safe work practices and procedures (for example, a safety observer, or ‘permit to work’ etc).

The best way to eliminate the hazard is by preventing people, plant, equipment and materials from coming close enough to energised overhead electric lines for direct contact or ‘flashover’ to occur. Consider:

- De-energising the electric line;
- Isolating and earthing the line for the duration of the work;
- Re-routing the electric line away from the work area.

Where elimination is not reasonably practicable, minimise the risks by substituting the hazard or work practice with something safer for example by:

- Using alternative plant that cannot enter an unsafe zone;
- Using non-conductive tools;
- Using ultrasonic measuring devices to measure the height of overhead lines.

## SECTION 10: On-Site Management of Hazards and Risks (Site Rules) (continued)

Consider isolating the hazard from people by erecting a physical barrier to prevent any part of the plant or equipment or a person, or anything held by a person, or attached to a person entering the unsafe zone or, use engineering controls like:

- Limiting movement of plant with mechanical stops;
- Fitting plant with programmable zone limiting devices;
- Mechanically limiting the slew speed of a crane to slow using electrically insulated plant and equipment.

If a risk still remains use administrative controls, such as:

- Fitting proximity sensors and a warning device to plant to alert operators when they are about to enter the unsafe zone;
- Making hazards more visible (for example, use warning signs or tiger tails);
- Managing and supervising the work;
- Defining areas where plant should not enter (for example, rigid tape barriers or use high visibility bunting).

Use suitable PPE, such as:

- Electrically tested insulating gloves;
- Rubber soled boots;
- Safety helmets;
- Stand on a rubber insulating mat or on an equipotential conductive mat;
- Wear dry clothes especially in wet or humid conditions;
- Wear fire retardant clothing.

A combination of the above controls can be used if a single control is not enough to minimise the risks.

You must check with your state-based service provider for the specific clearance distances required in your state or territory. You must also comply with any relevant Code of Practice or Compliance Code, and use the free Look Up and Live website or app.

# SECTION 10: On-Site Management of Hazards and Risks (Site Rules) (continued)

Clearance distances or easement requirements for Overhead Power lines vary from state to state. Some examples of Overhead Power Line clearance distances are included below.

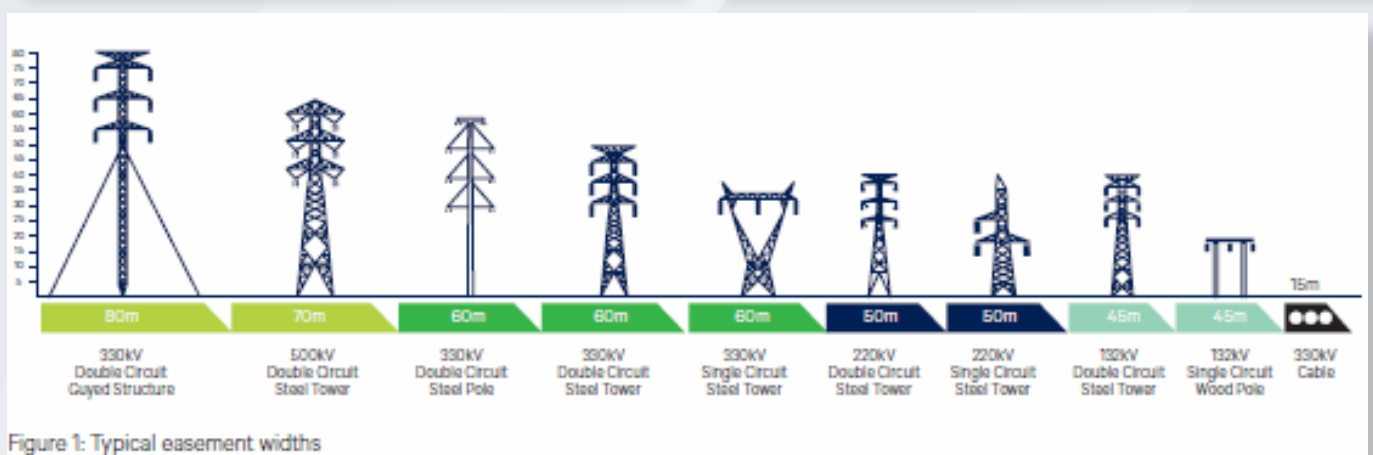



## SECTION 10: On-Site Management of Hazards and Risks (Site Rules) (continued)

### 10.18 WORK NEAR ENERGISED ELECTRICAL INSTALLATIONS (OTHER)

Most NEX Building Group sites have live power connected at slab stage, therefore all workers working on site must be aware that they are working near energised electrical installations. The following controls must be followed:

- Always assume power is live;
- Only licensed electricians approved by the NEX Building Group are authorised to complete electrical work;
- Never attempt to move power points or other electrical installations. Contact the Site Supervisor if there are any issues;
- Use lock out/tag out procedures when working on electrical installations. The person that placed the lock out tag is the only person that can remove it;
- Check underground diagram in lid of meter box before breaking ground;
- Identify and mark out existing services before breaking ground;
- Manual digging with non-conductive tools within 1 metre of identified services;

- Take care when working near the electrical mains lead in and meter box, and ensure you locate the power and isolate the area before working in proximity to the meter box;
- Never drill, cut or penetrate a surface within 1 metre of an electrical installation without first locating and isolating the electrical installation.

### 10.19 DEMOLITION

Where the demolition of a structure is completed by contractor directly engaged by NEX Building Group, we will ensure the following:

- Only licensed and qualified demolition contractors are engaged;
- The demolition contractor provides a SWMS for the proposed work before work commences;
- The demolition contractor or client has arranged and confirmed disconnection, capping or other such control of all electric, gas, water, sewer, steam and other service lines at or outside the building line that are not required in the demolition process;

## SECTION 10: On-Site Management of Hazards and Risks (Site Rules) (continued)

- The demolition contractor completes a risk assessment of the site to determine if there are any items which could be a fire or explosion risk, any previous use of the site might cause a risk due to its nature or decomposition of materials, and if there are any toxic, radioactive or other hazardous chemicals present. If any of these risks are present, appropriate controls must be applied by the contractor;
- A copy of the asbestos register is obtained before demolition commences;
- Where there is no asbestos register, we will ensure the contractor does not carry out the work until the structure has been inspected by a competent person to determine whether asbestos or asbestos containing materials are fixed or installed in the structure;
- Where asbestos is determined or presumed to be present, the contractor must inform the owner of the premises and NEX Building Group.

The contractor must ensure that all asbestos has been removed before demolition commences and must also provide NEX Building Group with the following:

- Council approval for demolition;
- Relevant asbestos removal licence;
- Relevant demolition licence;
- A NATA certified site hygiene clearance certificate;
- Copies of the receipts of disposal of the asbestos at an approved facility;
- Any relevant plant and equipment maintenance records.

### 10.20 EXCAVATIONS

A person conducting excavation works must manage the risks associated with:

- An excavation collapsing;
- Objects falling into an excavation;
- A person falling into an excavation;
- A person being exposed to airborne contamination or other impurity of the air in the excavation;
- The unearthing of asbestos containing materials (ACM).

## SECTION 10: On-Site Management of Hazards and Risks (Site Rules) (continued)

A person conducting excavation works must decide on and use appropriate control measures and maintain the control measures necessary to prevent, or minimise the level of, exposure to the risk.

A person conducting excavation works must implement any control measures necessary to prevent risk from the collapse of another structure such as an adjoining building or road.

A person conducting excavation work needs to ensure that if a person is entering a trench more than 1.5 metres deep, at least one of the following control measures is implemented:

- There is safe access into, and out of the trench;
- Has shoring or shielding;
- Is benched – not higher than it is wide and no vertical face exceeding 1.5 metres;
- Is battered – angle not exceeding 45 degrees and bottom vertical face not exceeding 1.5 metres;
- Is approved in writing by a geotechnical engineer as safe to work in;
- Consult with a geotech after rain.

### 10.21 SWIMMING POOLS

Where a pool is on site, the following controls must be followed:

- If the pool is within 3 metres of the projected gutter line, a hard cover working deck must be installed that has a minimum SWL of 225kg;
- If the pool is more than 3 metres of the projected gutter line and does not affect the construction, a pool fence compliant with the relevant state or territory Swimming Pools Act must be installed and maintained for the duration of the construction;
- If the pool shell is kept dry i.e., constantly pumped out to remove the risk of drowning, construction fencing around the perimeter to secure the fall risk is required;
- Relevant safety signage as required by individual state legislation and local councils.

### 10.22 CONFINED SPACES

NEX Building Group standard residential construction designs do not entail work in confined spaces; however, if the design of the construction should require work to be done in a confined space, relevant controls would be devised and implemented. On larger projects these risks will be covered in the project specific Risk Register.

# SECTION 10: On-Site Management of Hazards and Risks (Site Rules) (continued)

## 10.23 TEMPORARY SUPPORTS – PROPPING AND BRACING

### BALCONIES, PORTICOS, ALFRESCOS AND GARAGES

Wherever possible temporary propping of a structure should be eliminated by timing the works such that permanent fixing of the elements into position can be completed. When temporary propping is necessary, the following controls must be followed:

- Wherever possible the use of permanent sacrificial posts should be used;
- The system must be designed and engineered to resist all expected loadings including construction loads, live loads, lateral loads, bad weather, subsidence and wind;
- Erected and installed as per the structural engineers specifications and standards;
- Engineered for adequate strength, stiffness and stability;
- Of such material and large enough to hold the weight of workers and their tools and materials;
- Appropriately braced to resist bending under load. The props used should not bend. If they do, they need to be immediately replaced;

- Adequately secured at the top and bottom to prevent dislodgement;
- Props supporting the load above should be perpendicular to the ground and the roof i.e., they should be perfectly vertical;
- No trade is to remove any temporary propping. If propping is impeding the work area, the trade is to contact the Site Supervisor for assistance and direction.

### FRAMING

- Bracing for domestic residential framing should be installed as per engineers requirements and design and the framing code AS 1684 series.

### BRICKWORK

- Green masonry must be constructed sequentially so that cross walls or returns are constructed at the same time, providing lateral support for each other;
- Each lift should be limited in height to avoid overloading;
- Avoid lateral loading such as impacts by pedestrians, vehicles and stored materials;
- Where required, provide additional support for lintels or other structural elements that place concentrated loads onto green masonry.

## SECTION 10: On-Site Management of Hazards and Risks (Site Rules) (continued)

### 10.24 POWERED MOBILE PLANT & EQUIPMENT (CRANES, CONCRETE PUMPS, EWP ETC.)

All powered mobile plant and equipment prescribed under the WHS Regulations must have the following:

- Be assessed, approved and registered for use within the NEX Building Group WHS Compliance system. Where the plant is not already registered with the NEX Building Group, the contractor must contact the NEX Building Group to obtain approval;
- Health and safety information and/or risk assessment for safe operation of that piece of plant or equipment available;
- Current plant item registration;
- Relevant servicing details and logbooks available for inspection;
- Daily pre-start inspection checklist;
- User manual with the item of plant;
- Only be operated by qualified, competent and trained persons;
- Adequate guarding on moving parts;
- Roll over protection (ROPS) and falling object protection (FOPS) if required;
- A flashing warning light and reversing/motion alarm;
- Safety pins and locking devices;
- Seatbelts;
- Approved and compatible attachments (e.g., for use on telehandlers);
- Burst protection on boom and dipper arms (applies only to excavators used as cranes and >1 tonne capacity);
- Traffic management in place where there is a risk of contact with pedestrians or workers;
- When not in use, be stored such that it does not create a health and safety hazard to persons or its surroundings, and be adequately secured to protect from unintended or unauthorised use.

## SECTION 10: On-Site Management of Hazards and Risks (Site Rules) (continued)

### MOBILE CRANES

Supplementary to 10.24 of this documents, operators of mobile cranes must also provide the following:

- An engineer’s certification on point loading if the crane is operating on suspended slabs;
- A geotechnical engineer’s report of the ground bearing capacity if loads to be lifted are greater than 50 tonnes;
- Annual and ten-year major inspection records (where applicable);
- A qualified dogger to sling and supervise all crane lifts;
- Dunnage or bog mats for use under outrigger pads, irrespective of ground or surface conditions.

The crane operator must also ensure that:

- Consultation occurs with NEX Building Group regarding:
  - Crane selection;
  - Access to and around site;
  - Crane set-up and siting;
  - Proximity of overhead and underground services;
  - Any other relevant site information.

- Mobile cranes are fitted with the following:

- Mobile cranes compliance plate compliant with AS1418.5;
- Load charts;
- Load indicators (>3t capacity only);
- Radius indicator; and
- Motion limiters (hoist, luff angle, telescoping and slew functions where applicable).

### CONCRETE BOOM PUMPS

Supplementary to 10.24 of this document, operators of concrete boom pumps must also provide the following:

- Records of annual inspection by a competent person;
- Evidence of engineer’s certification for continued service based on six-year strip down (where applicable);
- Evidence of monthly ultrasonic test records of pipe sections or equivalent evidence of wear and service if twin-wall pipe sections are used.

## SECTION 10: On-Site Management of Hazards and Risks (Site Rules) (continued)

The concrete boom pump operator must also ensure that consultation occurs with NEX Building Group regarding:

- Selection of the placement boom;
- Access to and around site;
- Pump set-up, siting, operation and cleaning;
- Processes for delivery of concrete (including exclusion zones, spotters, movement of agitators, traffic control etc.);
- Any other issues that may impact on the safe operation of the placement boom such as proximity of overhead powerlines, cranes, structures and other plant.

### 10.25 WORKING AT HEIGHTS BELOW 2M

Any works performed below 2m must have the following controls implemented:

- Completing a SSRA that confirms:
  - Workers fall zone to be less than 2m;
  - Ensuring stability i.e., work platform is level and appropriately supported;
  - Ensuring that access and egress is via a secured and compliant ladder that extends 1 m above the platform step off point;
  - Ensuring load limits are not exceeded;

- Where 2 or more workers are on the platform, that they are not crossing over each other;
- Ensuring an exclusion zone is in place (usually 2m but may be less due to site restrictions) below the vicinity of the edge, and that this zone does not contain any housekeeping hazards, other plant and equipment or other workers working.
- Ensuring that all workers are trained in their safe operating procedures relating to the installation and use of scaffold and ladders;
- Ensuring that all plant is installed and maintained as per manufacturer's instructions.

## SECTION 10: On-Site Management of Hazards and Risks (Site Rules) (continued)

### 10.26 WORKING AT HEIGHTS 2M & ABOVE

Any works performed at 2m and above must be performed off a suitable scaffold or platform with adequate edge protection system installed. The most common forms of fall protection in the residential construction industry are:

- Perimeter scaffolding;
- Hanging bracket scaffolding – Light Duty Working Platform (LDWP);
- Independent rafter or roof post and rail systems;
- Stair void platforms.

### 10.27 SCAFFOLDING

The following general requirements apply in relation to scaffolding:

- Evidence of design registration must be provided to NEX Building Group for all prefabricated scaffolding;
- The design, erection, dismantling, maintenance and inspection of all scaffold must comply with AS/NZS 4576 and the appropriate parts of the AS/NZS 1576 series; and manufacturers/suppliers' specifications;

- Scaffold must be used only for its intended purpose. It must not be used to support other materials, which may exceed its rated capacity;
- All scaffolds over 4 metres in height must be installed by a licensed and competent scaffolder;
- No one other than the licensed scaffolder that installed the scaffold can remove guardrails, planks, brick guards or other scaffold components;
- Handover certificates must be provided by the scaffolder for all scaffolds;
- The scaffolding must be reinspected by the scaffolding contractor at least after:
  - Every 30-day period;
  - Storms, heavy downpours or any adverse weather event that may affect the integrity of the scaffold;
  - Sustaining structural damage (e.g., contact by fixed or mobile plant, collapse, overloading, struck by heavy falling objects or materials, etc.);
  - After use by each individual trade e.g., after brickwork, before use by renderers or painters;
  - If the scaffold has been altered with any components handrails, intermediates, walkway planking and kickboards missing;



## SECTION 10: On-Site Management of Hazards and Risks (Site Rules) (continued)

- All scaffolding must be loaded as per the Load Specification identified on the scaff-tag or SACS card located at the scaffold ladder access bay. If the scaffold is rendered unsafe or incomplete remove the scaff-tag or SACS insert to reveal the “do not use scaffold” and contact the Site Supervisor immediately;
- Workers must visually inspect scaffold before use to ensure the scaffold is complete with kickboards or brick guards, mid and tops rails in place, and safe access between levels;
- If scaffold is unsafe or needs to be altered speak to the Site Supervisor immediately.

### EXAMPLES OF WEIGHTS ON SCAFFOLDING

The scaffold duty classification is dependent on the following:

Key:	Description	Weight
Materials	Standard (Dry) brick	4 kg
Tools	Average batch of mortar equals	25 kg
Persons	Average person	80 kg

### HEAVY DUTY SCAFFOLD

Table 1: Weight for one person, tools and materials per bay:

Qty	Description	Weight
1	Tradesperson	80 kg
1	Mortar to service 1 bricklayers	25 kg
135	Bricks @ 4 kg per brick	545 kg
	<b>Total</b>	650 kg

# SECTION 10: On-Site Management of Hazards and Risks (Site Rules) (continued)

## MEDIUM DUTY SCAFFOLD

Table 2: Weight for one person, tools and materials per bay:

Qty	Description	Weight
1	Tradesperson	80 kg
1	Mortar to service 1 bricklayers	25 kg
80	Bricks @ 4 kg per brick	320 kg
<b>Total</b>		425 kg

## LIGHT DUTY SCAFFOLD

Table 3: Weight for one person, tools and materials per bay:

Qty	Description	Weight
1	Tradesperson	80 kg
1	Mortar to service 1 bricklayers	25 kg
20	Bricks @ 4 kg per brick – depending on access and egress along the working platform	80 kg
<b>Total</b>		185 kg

### IMPORTANT NOTE:

For every extra person working in a scaffold bay, the number of bricks must be REDUCED by 32.

If edge protection is NOT installed, then bricks are NOT to be stacked above the toe/kick board.

### SCAFFOLD ERECTION AND DISMANTLING PERIMETER SCAFFOLDING ERECTION

While erecting, altering or dismantling the scaffolding, the subcontractor must:

- Supply scaffolding plans to NEX Building Group before work starts;
- Adhere to scaffolding plans and install components systematically in accordance with the manufacturer’s specifications.

Persons erecting or dismantling scaffolding at 2m and above must:

- Be prevented from falling by either of the following:
  - Retain a full deck of platform until the platforms are transferred on erection or dismantling;
  - Immediately install platforms, edge protection and a means of safe access as each level is erected;

## SECTION 10: On-Site Management of Hazards and Risks (Site Rules) (continued)

- Use a platform at least 450mm (2 planks) wide along the full length of the section to erect components to the level above;
- Provide a fully planked deck no more than two metres below. This equates to fully planking every second lift to the full height of the scaffold;
- Fit edge protection as soon as the planks in each bay are installed;
- Provide a means of safe access (ladders or stair pans) to the level the scaffolding has reached, before the next level of scaffolding is erected.

# SECTION 10: On-Site Management of Hazards and Risks (Site Rules) (continued)

## PERIMETER SCAFFOLDING DISMANTLING

– The reverse sequence to the above steps should be used for dismantling;

– Bombing (throwing or dropping) of scaffolding components is strictly prohibited.

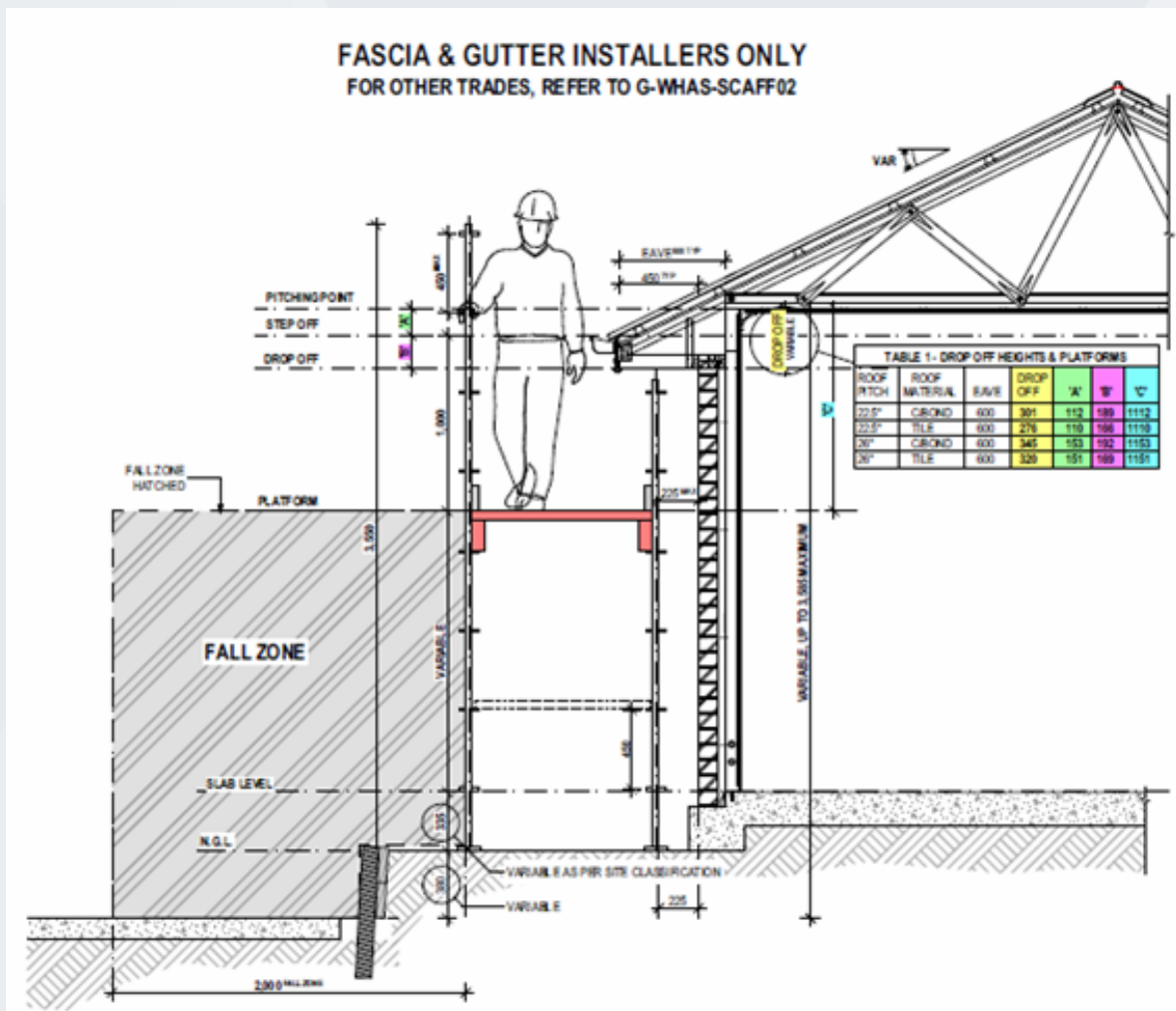

# SECTION 10: On-Site Management of Hazards and Risks (Site Rules) (continued)

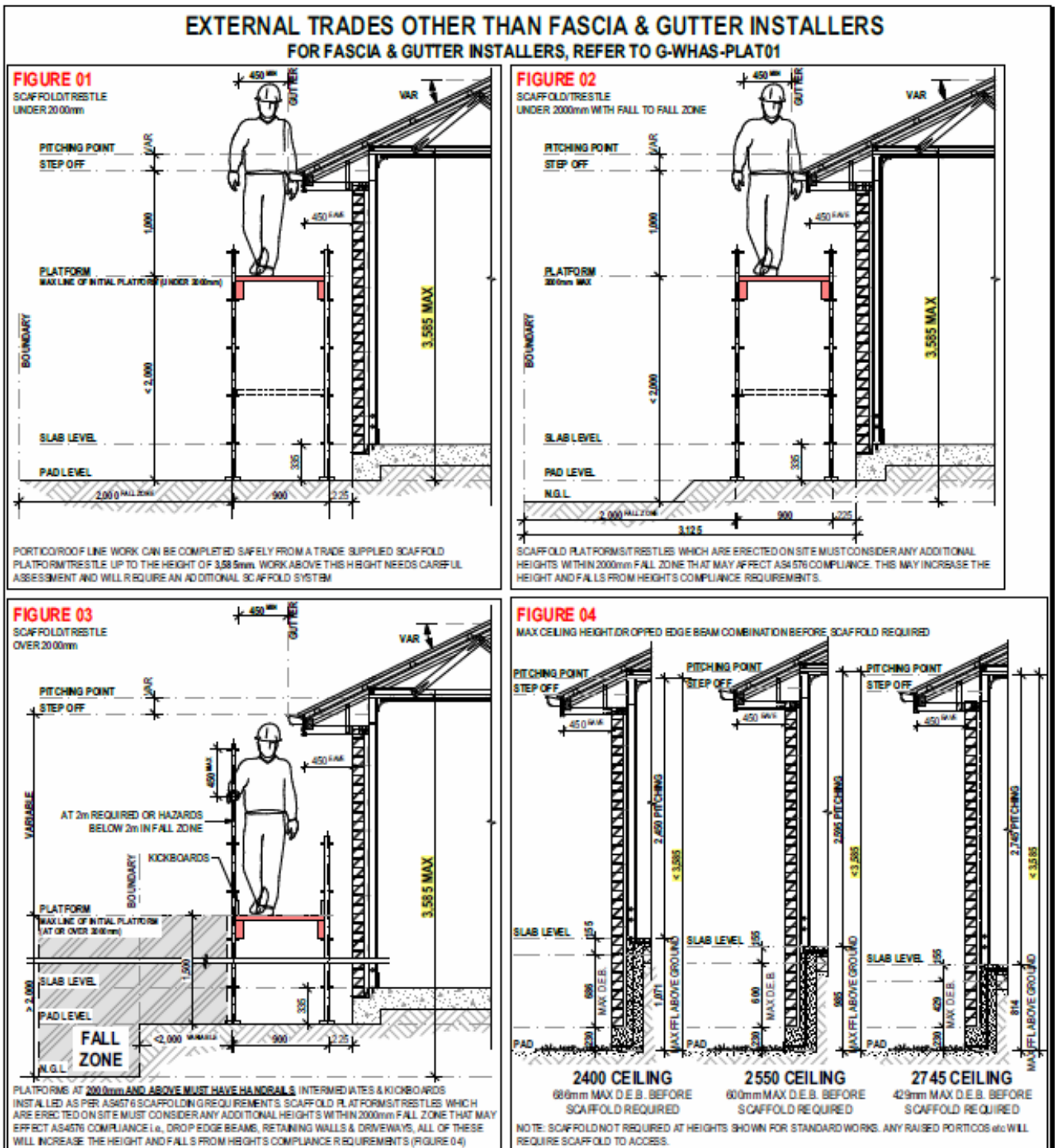

## SECTION 10: On-Site Management of Hazards and Risks (Site Rules) (continued)

### CATCH PLATFORMS

Catch platforms may be constructed from different types of systems. Catch platforms are used to control the risk of a fall:

- Where the roof pitch is not greater than 26 degrees, should be positioned as close as feasible to the underside of the roof, and in no case greater than 1m below the roof edge;
- Where the pitch of the roof is greater than 26 degrees, should be positioned as close as feasible to the underside of the roof and in no case more than 500mm below the roof edge;
- Must have a guardrail. The top rail should be located at an effective height of not less than 900mm above the point where the roofline projection intersects the guard railing, installed with 450mm mid-rails;
- Where there is an increased risk of falling due to slippery roofing materials (such as fully glazed tiles or the presence of dust, moisture or oil on roofing) should be positioned not more than 500mm below the roof edge, regardless of roof pitch;
- Should incorporate a toe board at the platform's outer edge;
- Should be extended to finish not more than 225mm from the building face or be fitted

- with edge protection on the platform's inner edge;
- Should be kept clear of equipment, materials and debris.

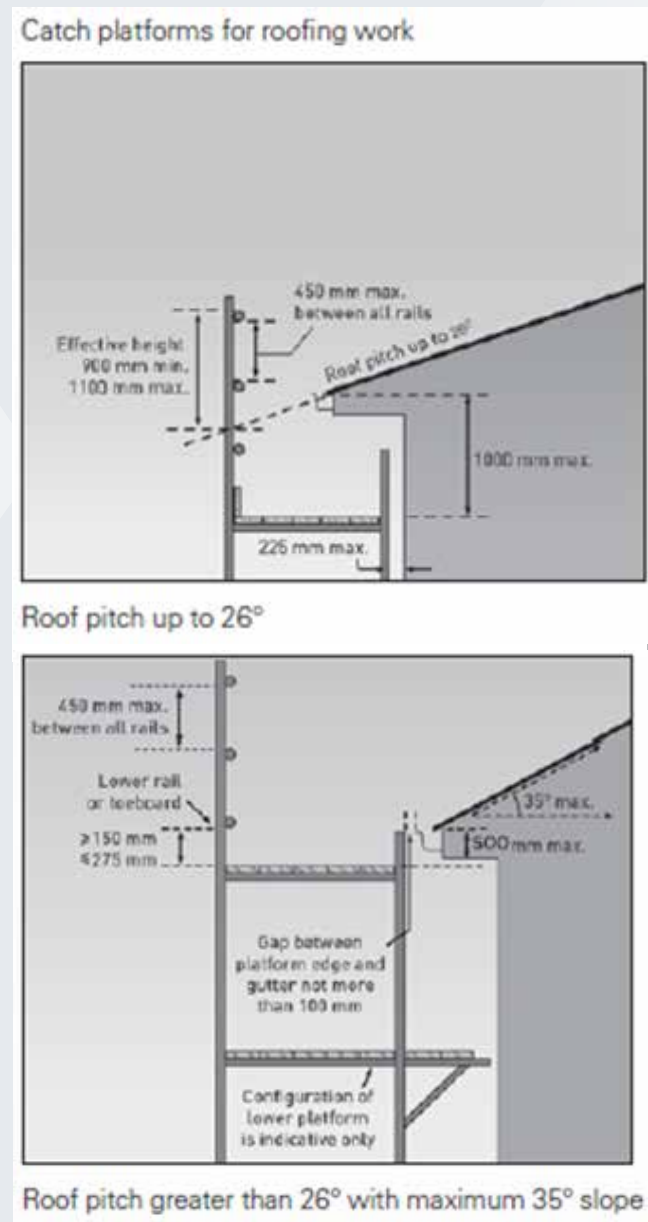

## SECTION 10: On-Site Management of Hazards and Risks (Site Rules) (continued)

### ROOFING TASKS

Roofing work involves several tasks that potentially expose persons to the risk of falls both through and from the edge of the roof structure. Physical edge protection must be provided for all roofing works, so far as is reasonably practicable.

This section gives basic advice on the provision of fall protection for roofing construction work. This plan is not intended as complete guidance where the roofing work involves dismantling or demolition work.

### CRITICAL ANGLE

The pitch of the roof is one of the key risk factors to be considered when determining the type of risk control measures to be put in place for roofing work. The critical angle is the roof pitch below which it is considered roof workers may reasonably be able to work and walk across the roof.

Builders and subcontractors should determine the critical angle as part of their risk assessment. In no case should the critical angle be taken as greater than 26 degrees or 10 degrees where the presence or likelihood of surface moisture, oil or other conditions makes the roof slippery. Consideration should be given to the fact

that the critical angle may be reduced in the presence of fully glazed and wet tiles.

### ACCESS AND EGRESS

Safe access must be provided for workers carrying out work on the roof. Depending on the edge protection system being used, it must be set up so that:

- Persons are able to access the roof through the roof edge protection without having to climb over the top rail or mid-rail;
- Access ladders are secured against movement;
- Where a platform is located more than 500 mm below the roof edge, then additional means of access to the roof is provided;
- Where an elevator, hoist or similar is used, it is installed so that materials can be received at the roof level.

## SECTION 10: On-Site Management of Hazards and Risks (Site Rules) (continued)

### GUARDRAIL SYSTEMS FOR ROOFING WORK

Guardrail systems should include top, mid and bottom rails or toe-boards. Where toe-boards are used in place of bottom rails they must be able to withstand the likely impact loads.

Guardrail systems should include the following:

- Toe-boards or mesh infill to prevent tools, materials or debris falling from the roof, unless a 2m 'no go' zone has been established to prevent persons entering the area below;
- A clear gap between rails not exceeding 450mm. The clear distance between a mid-rail and a toe-board or bottom rail should not exceed 275mm;
- No gap between the roof edge, including the gutter, and a guardrail located outside the roof line exceeding 100mm;
- A clear distance between the roof cladding and the bottom rail of not less than 150mm and not greater than 275mm;
- An effective guardrail height above the roof surface of not less than 900mm (for roofs with a pitch over 10 degrees the effective height must be measured from a point 300mm inside the roof edge);
- Infill panels where the pitch of the roof exceeds 26 degrees.

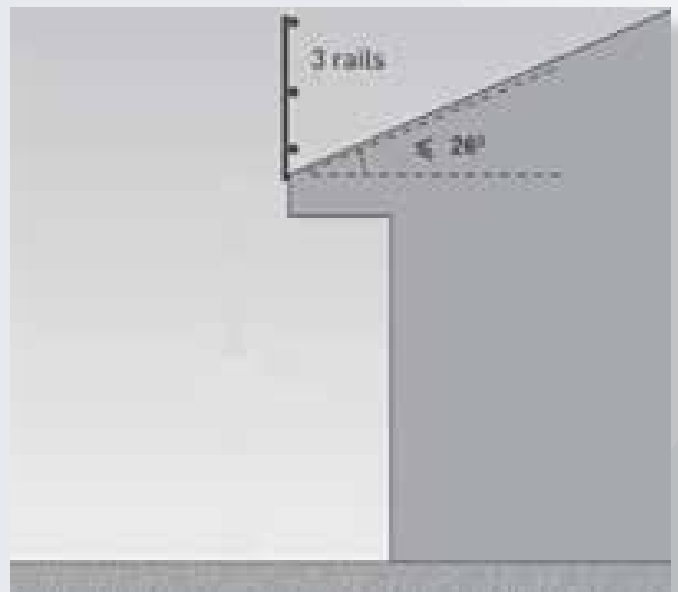

Fall height greater than 2m – roof pitch at or below 26°.

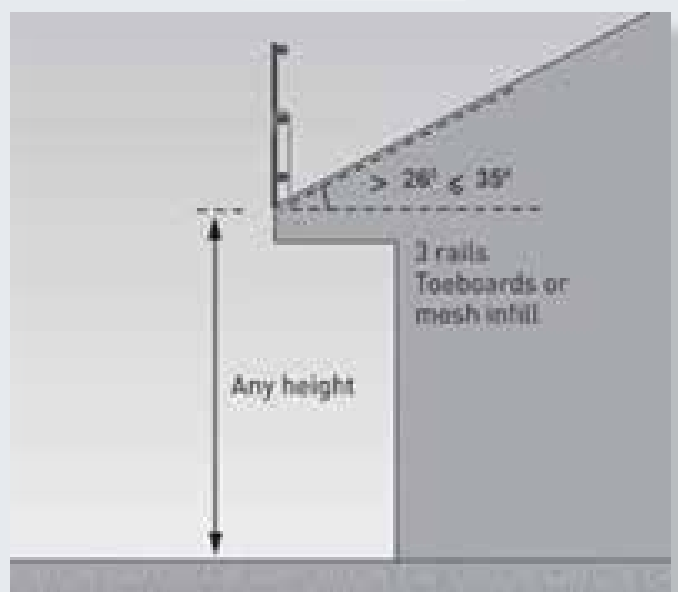

Roof pitch greater than 26°.



## SECTION 10: On-Site Management of Hazards and Risks (Site Rules) (continued)

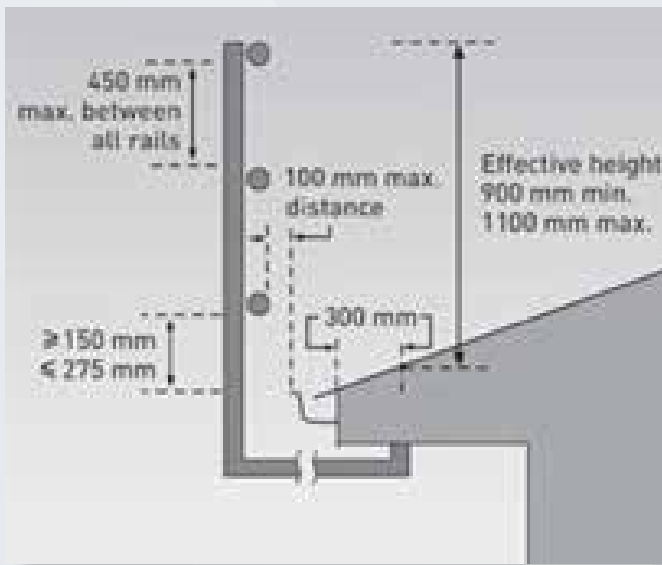

### GUARDRAIL OUTSIDE ROOF LINE

(Note: if gutter not present, then the 100mm maximum distance is measured from the fascia board or outer ends of the rafters or top chords to trusses).

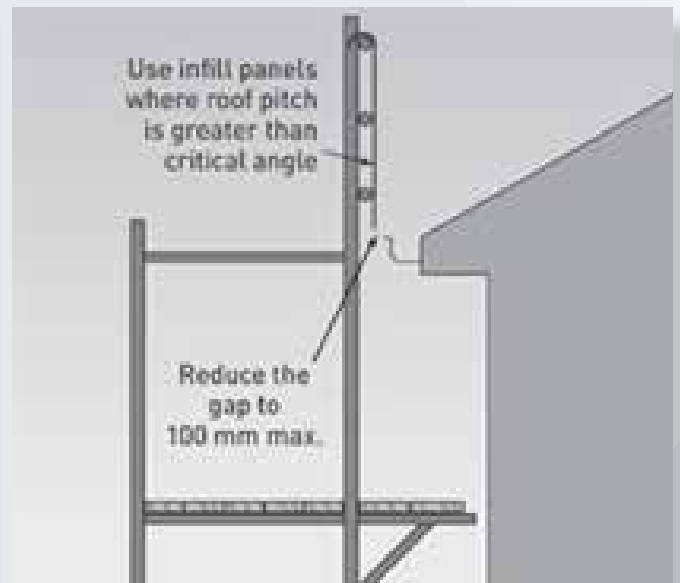

Scaffolding providing guardrail protection.

## SECTION 10: On-Site Management of Hazards and Risks (Site Rules) (continued)

### **HANGING BRACKET SCAFFOLDS/LIGHT DUTY WORKING PLATFORMS (LDWP)**

The following measures are to be implemented for hanging bracket scaffolds:

- Hanging bracket scaffolds and their means of support should be designed by an engineer with a minimum safe working load of 225kg;
- Spacing of brackets should not exceed the maximum planks spans specified by the designer or manufacturer guidelines;
- Planks may overlap planks on straight runs on hanging bracket scaffolds;
- Planks should overlap their supports by not less than 150mm or more than 250mm;
- Working platforms should be a minimum 450mm wide;
- Planks should be secured (for example – clamped) to prevent any movement.

# SECTION 10: On-Site Management of Hazards and Risks (Site Rules) (continued)

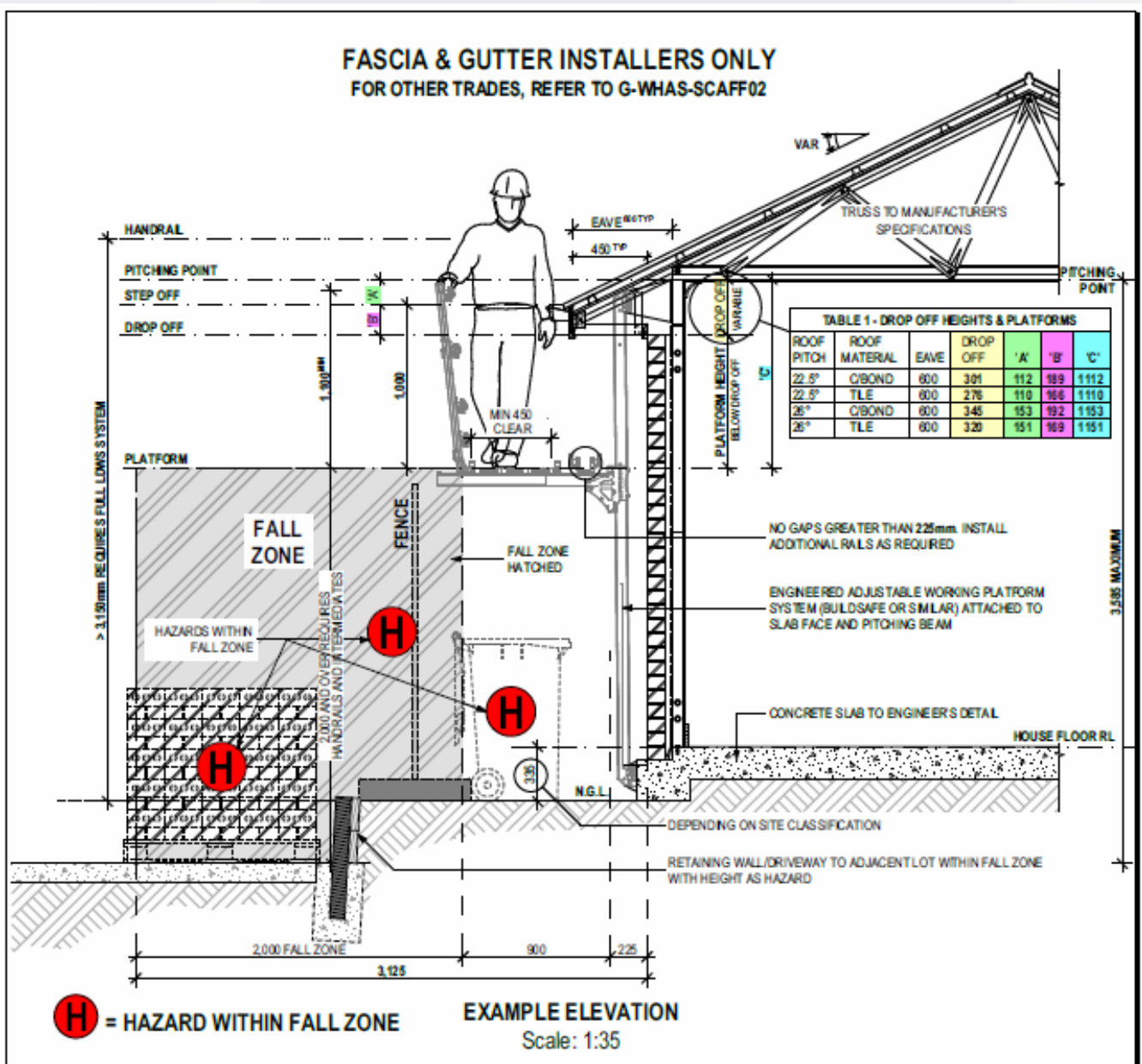

# SECTION 10: On-Site Management of Hazards and Risks (Site Rules) (continued)

## STAIR-VOID PROTECTION SYSTEM & GUARDRAILS

Altering safety systems is prohibited. Stair-void protection systems & guardrails must remain in place at all times when persons are working on the upper level. The stair-void access hatch must be closed at any time other than when moving between levels.

If the stair-void protection system or any part of the stair-void protection system is not installed, then stop work, and contact the Site Supervisor/Manager immediately.

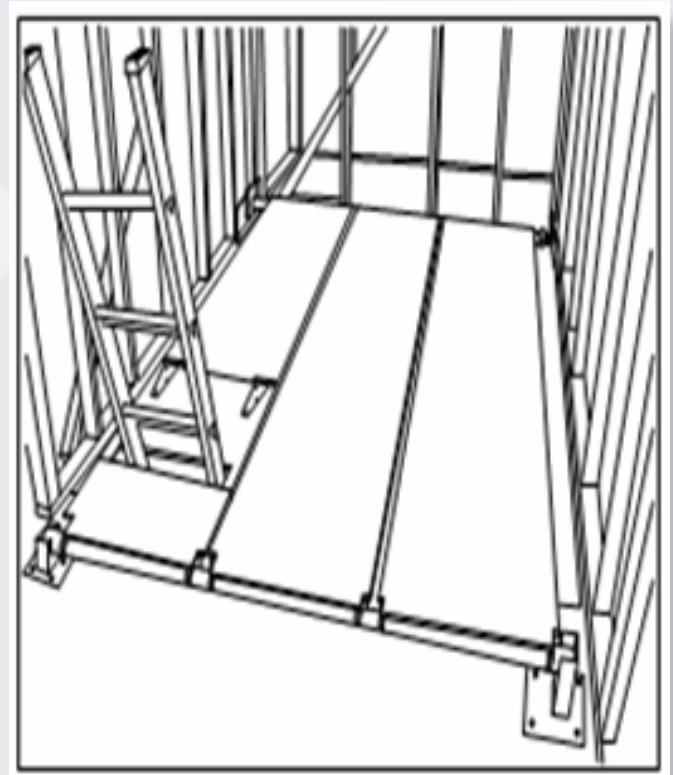
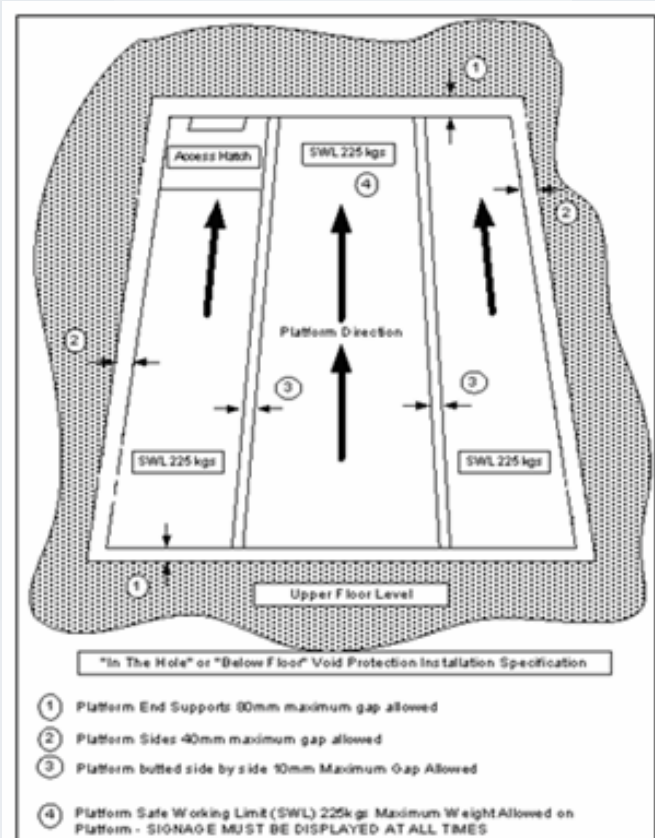

## SECTION 10: On-Site Management of Hazards and Risks (Site Rules) (continued)

### 10.28 FALLS THROUGH EXCAVATIONS, PENETRATIONS & FLOOR OPENINGS

Each contractor/PCBU is responsible for ensuring any trenches or holes they create are made safe using suitable means. Floor and window openings and excavations are to be adequately guarded or barricaded or otherwise protected to prevent someone falling. If a barrier is removed for work, it must be replaced immediately and before leaving the work area.

### 10.29 FALLING OBJECTS

The following controls are provided to contain and minimise the risk of falling objects on assumption falling objects cannot be eliminated:

Whenever possible eliminate the risk of falling objects by:

- Lining the scaffold or guardrail with mesh/ shade-cloth;
- Including brick-guards or toe-boards on scaffolding decks above 2m;
- Including toe-boards on roof and perimeter guardrail systems.

Where the risk of falling objects cannot be eliminated, one or more of the following controls may be implemented:

- Temporary perimeter fencing;
- Work sequencing to ensure trades do not overlap;
- Tool lanyards;
- Physical exclusion zones using hazard tape or traffic cones etc;
- Signage such as ‘Workers above – do not enter’;
- Allocated drop areas for tilers or roofers;
- All persons to be kept out of an adjoining area where loads are being lifted;
- Temporary footpath closures;
- Approved road closures.

A SSR) must be completed prior to commencing work to assist in the selection of the most appropriate and effective controls.

## SECTION 10: On-Site Management of Hazards and Risks (Site Rules) (continued)

### 10.30 HARNESSSES

Where work cannot be undertaken on the ground or in an enclosed environment with edge protection and properly covered penetrations, other controls such as travel restraint systems should be used. Fall-arrest systems are generally not suitable for most housing work, especially where the fall height is less than six metres.

A SWMS prepared by a subcontractor for the risk of persons falling more than 2m cannot only include administrative controls or PPE (e.g., harnesses) to control the risk. The SWMS must list any higher level controls, such as edge protection or scaffolding that were considered for use.

Any subcontractor intending to use boom lifts, fall-arrest or travel restraint systems must ensure:

- Workers are properly trained in their use, as well as any emergency rescue and retrieval procedures;
- Harnesses are worn at all times;
- Rescue procedures are included in any SWMS;
- Any anchor point, to which a harness is attached, has a minimum rating of 15kN;
- Any fall restraint/arrest system/harness is inspected visually before use and periodically in accordance with the relevant standards and according to manufacturer's instructions.

### 10.31 LADDERS

All ladders MUST conform to the Australian Standard and be of industrial grade and rated no less than 120kg. Ladders should be maintained in a sound working condition.

Single or extension ladders may only be used:

- To gain access;
- To carry out permitted work – where the material or equipment being carried does not restrict movement or cause loss of balance;
- If no major tasks are to be undertaken while working off a ladder;
- If the trunk of the body remains centred on the ladder;
- If equipment can be used with one hand (unless a control to prevent a fall is used).

## SECTION 10: On-Site Management of Hazards and Risks (Site Rules) (continued)

A person using a ladder for access or permitted work must:

- Have three points of substantial contact with the ladder or a stable object (for example, standing on the ladder with two feet while holding a fascia board or timber stud);
- Be secured against movement at or near its top or bottom (for example, by tying or clamping);
- Be set up on a firm and stable surface;
- Be placed at a ratio of 1:4;
- Be extended at least 1m above a surface being accessed;
- Be removed from site at the end of every working day.

### STEPLADDERS

Correct selection of an appropriate type of stepladder is the key for ensuring safety during use. Before using a stepladder, check the following:

- The ladder is set up for use in the fully opened and locked position;
- All components are in a good serviceable working order;
- The person's feet should be no higher than the second tread from the top step;

- The stepladder is not near the edge of an open floor or penetration where, if the ladder toppled, a person could fall over the edge or through a penetration.

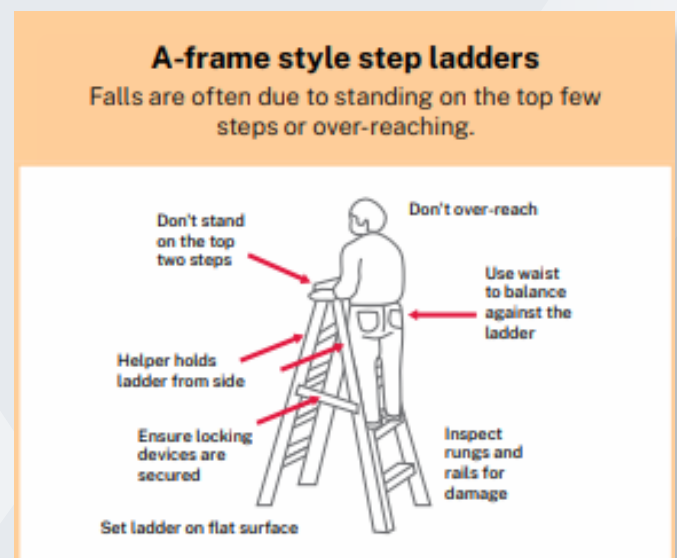

### TRESTLE LADDER PLATFORM SYSTEMS

Platforms used on trestle ladders below 2m must be 450mm wide unless the work is light work. Examples of light work include:

- Painting, installing a roof gutter,
- Air-conditioning duct work, metal fascia or lighting installation;
- Performing inspections or tests;
- Installing an electrical connection.

## SECTION 10: On-Site Management of Hazards and Risks (Site Rules) (continued)

Fixing plasterboard sheeting to an internal stairwell void, fixing cladding to a gable end of a roof or using a medium or heavy-duty angle grinder or circular saw are not considered light work.

For work construction on a trestle ladder at or above 2m in addition to above:

- Must have installed handrails, intermediates and kickboards along outer length of the platform;
- The gap between the inner edge of the platform and face of a building/structure must not be greater than 225mm;
- Each trestle ladder must be secured to prevent it moving via an approved method, in line with the designer’s and manufacturer’s specifications and instructions.

### 10.32 WORKING BELOW OTHER TRADES

The Site Supervisor will endeavour to schedule so that there are no trades working underneath other trades working at height. For example, the roofing contractors and scaffolders should be able to do their work without workers beneath them. If a clash occurs, contractors must contact the Site Supervisor who will decide on which trade will need to leave the site.

### 10.33 DANGEROUS PROTRUSIONS – IMPALING ASPECTS

Star pickets and reinforcement bars, nails or other protruding objects (for example – copper pipes etc.) that protrude from surfaces should be made safe. Yellow plastic caps are not a protection for impalement. If there is a risk of anyone falling onto reo bar or star pickets, the area must be barricaded off.

### 10.34 HIGH-RISK WORK LICENCES

All persons whom intend to perform high-risk work must hold the appropriate licence to perform that high-risk work (where required). The following types of work are considered high-risk work which require licensing through the state safety regulator:

- Vehicle loading cranes over (10t capacity);
- Non-slewing mobile cranes (over 3t capacity);
- Mobile crane operator (slewing up to 20t, 60t, 100t capacity and open classes);
- Boom type elevating work platform (boom length over 10m);
- Forklifts;
- Concrete boom pumps;
- Dogging;
- Scaffolding and rigging.



# SECTION 10: On-Site Management of Hazards and Risks (Site Rules) (continued)

Proof of Competency is required for other items of equipment including load-shifting machinery such as excavators and skid steers etc. Proof of training and competency must be carried at all times.

## 10.35 LIFTING EQUIPMENT

Contractors & subcontractors (trades/workers) who use lifting equipment as part of their work activity i.e., plant & equipment or tools, must ensure they are in good working order, serviced as per the manufacturer’s instructions and used correctly. A SSRA should also include these aspects before the work activity is undertaken.

## 10.36 INSPECTION OF LIFTING EQUIPMENT

All crane lifting points on plant and equipment must be designed and approved by a qualified engineer. The following lifting equipment must be visually inspected prior to use each day and then inspected and tagged by a competent person:

Item	Minimum Inspection Frequency
Chain wire rope slings	12 months
Synthetic slings	3 months
Lifting points on plant and equipment (e.g., skips, work boxes etc.)	12 months

## SECTION 10: On-Site Management of Hazards and Risks (Site Rules) (continued)

### 10.37 HAZARDOUS TASKS - MANUAL HANDLING/LIFTING

When completing manual handling tasks, the following controls must be followed:

- Avoid lifting excessively heavy loads - get help;
- Use mechanical lifting equipment where possible;
- Plan the lift by estimating the load and considering exactly where it is to be placed;
- Ensure that the access route and area is clear;
- Avoid bending your back to pick up a load
  - bend your knees and keep your back straight;
- Hold the load as close as possible to your body;
- Avoid twisting while lifting or carrying;
- Take care to reduce the likelihood of slips trips and falls which can jar the spine;
- Maintain overall physical fitness and use warm up activities to help avoid strain injuries;
- Use two people where lifting is required.

### 10.38 ELECTRICAL TOOLS & EQUIPMENT

When using electrical tools and equipment, the following controls must be followed:

- All electrical equipment must be protected by RCDs;
- All electrical equipment must be well maintained, fully serviceable, visually inspected before each use, and inspected and tested at three monthly intervals by an electrician or suitably qualified person. A method of recording the results such as individual tool tags, and/or tagging register must be used, test results should be recorded in a register by the electrician or suitably qualified person;
- All electrical extension leads shall be of heavy-duty type and not extended over 35m from the power source;
- Power leads are not to be located over roadways, footpaths or areas where persons may trip;
- Power on an adjacent house or block is not to be used unless express permission of the occupier is obtained. Obtaining power without permission is theft;

## SECTION 10: On-Site Management of Hazards and Risks (Site Rules) (continued)

- Electrical leads must not run through water or be on the ground in potential contact with mobile plant, machinery, metal objects, water or debris, or block walkways. Lead stands can be made out of excess timber or other non-conductive materials;
- When using power via the General Power Outlets (GPO) in the meter box, all leads must enter through the designated entry area at the bottom and be secured using the insulated tie bar to prevent strain on the socket/outlet;
- Meter box lid must be kept closed at all times other than when accessing switchboard;
- All RCD protection (portable and fixed power boards) must be tested on a three-monthly basis and comply with the industry standard;
- Double adaptors, domestic power boards and three-pin plug adaptors (piggy-back) must not be used on site, these can generally be identified by their white colour;
- All generators must be fitted with RCD protection and weatherproof power outlets. Generators must only be operated in well-ventilated areas;
- Electrical power isolations E-locks, lockout or danger tags are not to be removed unless authorised to do so;
- GPO must include RCD for the protection of electrical shock to all electrical devices connected to the general power outlets;
- Mains power switchboard must also be tested at monthly intervals and recorded;
- A suitable Fire Extinguisher i.e., Type (B) for flammable & combustible liquids – powder AB(E) or B(E) this covers both petrol operated and energised electrical equipment must be readily available for use on site or in the work vehicle.

### 10.39 PORTABLE GENERATORS

- All generators must have an RCD unit wired directly into the generator. Contractors who have not installed RCD units on generators will be asked to remove their generators from site until they have them fitted with RCD units;
- Generators must have an earth lead & stake for grounding to earth when in use;

## SECTION 10: On-Site Management of Hazards and Risks (Site Rules) (continued)

- Portable outlet devices that provide one or more outlets may be used subject to the following conditions:
  - They are of a robust double-insulated construction and have a minimum rating of IP33;
  - The switches controlling the socket outlets are to be double pole;
  - Socket outlets mounted on the assembly are protected against damage by extended sides or covers;
  - They incorporate an over current protection device with a maximum current rating of the supply flexible cord;
  - They incorporate an RCD which must be fitted at the plug attached to the supply flexible cord;
  - They are fitted with a heavy-duty sheath type flexible cord having a maximum length of 2m and a three-pin plug;
  - Any trip switches fitted must be added to the electrical tagging register and tested quarterly;
- When using petrol, the operator must also carry with them a fire extinguisher, and be aware of the controls within the SDS for the fuel being used;
- Must be allowed to cool down before refuelling;
- Appropriate funnel or spout must be used to fill the fuel compartment to ensure no fuel spillage;
- Do not overfill and leave room for expansion of fuel;
- If the fuel tank is overfilled and overflows, leave for 10 minutes for residual fuel to disperse (may cause flash back).

### 10.40 MACHINERY GUARDING

No machinery or equipment is to be used without the appropriate guarding in place as supplied by the manufacturer. This includes, but is not limited to; grinders, circular saws, compressors, cement mixers, etc.

### 10.41 NINE-INCH 9” (225MM) GRINDERS

Only trained and competent persons are to operate nine-inch (9”) grinders. Nine-inch grinders must never be used above the operator’s waist level and can only be used at ground level on material secured from movement.

### 10.42 NAIL GUNS

Nail guns should only be operated by competent trade persons in line with all the safety recommendations written by the manufacturer. When using pneumatic or gas canister nail guns the following controls must be followed:

## SECTION 10: On-Site Management of Hazards and Risks (Site Rules) (continued)

- Ensure all nail gun safety devices are in working order;
- Ensure the nail guns can only be used in bump fire mode when carrying out the following tasks provided a detailed risk assessment has been undertaken and there is no other reasonable way to carry out the task:
  - Constructing timber fences;
  - Fixing wind bracing (plywood);
  - Fixing flooring;
- Bump fire mode must not be used for framing tasks;
- Ensure apprentices never operate in bump fire mode under any circumstances;
- Document monthly inspections, noting any maintenance required;
- Ensure the area around or below the work site is clear of any personnel;
- Ensure personal protective equipment is being worn at all times;
- Ensure work areas are cordoned off with barrier tape or similar if there is a risk of others accidentally walking beneath nail gun work;
- Ensure all workers are trained and competent in the use of nail guns;
- Apprentices must be adequately supervised at all times.

### 10.43 EXPLOSIVE POWER TOOLS

Operators of explosive powered tools must be trained and competent. Ensure barriers and appropriate warning signs are in place prior to use of the tools. All explosive powered tools and spare charges shall be properly secured at all times.

### 10.44 WELDING AND CUTTING (HOT WORK)

When welding and cutting (completing hot work) the following must be undertaken:

- Complete a risk assessment prior to commencing;
- Check local fire restrictions if working outdoors. No gas cutting, gas welding or electric arc welding is to be carried on outdoors on a day of total fire ban unless a permit has been obtained from the local fire authority;
- Ensure appropriate fire fighting equipment is available for use, such as:
  - Fire extinguisher;
  - Charged hose;
  - Fire blanket;
  - Sand.

## SECTION 10: On-Site Management of Hazards and Risks (Site Rules) (continued)

- Wear the relevant PPE, such as:
  - Eye protection;
  - Face protection;
  - Gloves;
  - Suitable clothing;
- Unauthorised use of welding and cutting equipment is prohibited;
- Welding screens should be used wherever possible particularly if other workers may be exposed to welding activities;
- All equipment must be in good working order and appropriate firefighting measures must be available and ready for immediate use;
- Gas bottles are to be stored upright and securely chained to a solid object to prevent them from falling, and transported in accordance with relevant guidelines (in a vented area in vehicle);
- All oxy and acetylene equipment must be inspected prior to use.

### 10.45 LASER EQUIPMENT

Only Class 1, Class 2 and Class 3A lasers are permitted on-site for the purposes of alignment, levelling, control and survey tasks only. Lasers must be designed, constructed and installed so no person is exposed to accidental irradiation. Laser equipment on plant must also be protected

so that any operator of the plant or any other person is not exposed to direct radiation, radiation produced by reflector or diffusion of secondary radiation. Also, any visual equipment that is used for the observation or adjustment of laser equipment on plant must not create a health and safety risk from the laser rays. A worker operating lasers must be trained in the use of the equipment, and must ensure all safety signs and barriers are in place prior to use of the equipment.

### 10.46 ELECTRONIC DEVICES

The use of mobile phones whether talking, texting or data surfing is not allowed whilst undertaking work activities. Studies show a significant increase of injuries/fatalities to workers on mobile phones whilst continuing to work. To answer or make a call – stop work and step away from the work area to make or receive the call.

All radios or electronic music devices on site should be played at a reasonable (low) volume to ensure they do not create a noise hazard or annoyance to neighbouring properties.

# SECTION 10: On-Site Management of Hazards and Risks (Site Rules) (continued)

## 10.47 SUN PROTECTION & HEAT EXPOSURE (SUN SMART)

All workers should wear the appropriate UV protection when working outdoors and implement the following controls:

- Apply a broad spectrum sunscreen SPF30+ prior to commencing work. Reapply sunscreen every 2 hours if outside for prolonged periods;
- Wear adequate clothing, for example, long sleeves with a collar, hats with a broad brim and sunglasses. Please note that upper garments must be worn at all times;
- Maintain hydration.

## 10.48 ADVERSE WEATHER & CLIMATIC CONDITIONS

Work outdoors must cease during adverse weather conditions, or if directed by the Site Supervisor. Work on roofs must not be completed where the roof is wet due to overnight moisture or rain etc., and in high winds or where lightning is present.

Operation of cranes must cease if:

- The wind speed exceeds the maximum safe operation as indicated in the manufacturer’s instructions;
- Lightning is present;
- Excessive rain;
- Any other adverse weather conditions may affect safe operation.

## 10.49 REMOTE & ISOLATED WORK (I.E., LONE WORKERS)

When working on site alone, it is the responsibility of both the worker and their PCBU to ensure that they have access to a working mobile phone or similar means of communication in the event of an emergency, and an agreed check-in process whereby the worker is required to contact ‘home base’ at nominated times, or advise the Site Supervisor on arrival and departure or other agreed arrangements.

# SECTION 10: On-Site Management of Hazards and Risks (Site Rules) (continued)

## 10.50 YOUNG AND INEXPERIENCED WORKERS

To create a safe and healthy working environment for workers, we will ensure the employer understands that they must provide:

- The right tools, training and supervision to complete their work safely;
- Information about their health and safety rights and responsibilities;
- An environment where they are free to speak up about health and safety concerns and/or issues;
- A workplace culture that positively engages young and inexperienced workers in workplace health and safety.

## 10.51 ALCOHOL AND ILLICIT DRUGS

Alcohol and illicit drugs must not be brought onto or consumed on NEX Building Group sites. If anyone is suspected of being adversely affected by alcohol or drugs, they will be asked to leave the site and may face possible termination of employment or of their contract.

Persons taking a prescriptive course of drugs should follow the medicine’s instructions as they relate to use of plant, machinery and possible side effects that may impact their ability to carry out work tasks safely.

If any discarded hypodermic needles are identified on site, they must be safely disposed of. Contact the Site Supervisor to report.

## 10.52 FATIGUE

When allocating workers, all PCBU’s are responsible for ensuring that:

- An adequate number of personnel are provided to complete the works in accordance with their contract and demands of the building program;
- Consideration is given to rest breaks, work hours and travelling times to and from site;
- Other factors that contribute to fatigue, such as the physical demands of the work, climate, work environment, lifting equipment, storage and handling of materials, weight of loads, etc. are also considered.



## SECTION 10: On-Site Management of Hazards and Risks (Site Rules) (continued)

### 10.53 BULLYING, DISCRIMINATION & HARASSMENT

Under both Federal and State laws, it is unlawful to discriminate against people at work or in a work-related environment. Bullying, which includes behaviour that intimidates, offends, degrades, insults or humiliates a person, whether physically or psychologically, is a form of harassment and will not be tolerated on any NEX Building Group site. Persons found to be bullying or involved in violence will, at the discretion of NEX Building Group, be required to leave the site.

If any such instances occur, the Site Supervisor must be contacted immediately or telephone 24 Hour Emergency contact number listed on the site signage. All allegations will be investigated.

### 10.54 CHAIN OF RESPONSIBILITY

The NEX Building Group will ensure the following:

- Delivery requirements do not require or encourage drivers to:
  - Exceed the speed limit;
  - Exceed regulated driving hours;
  - Fail to meet the minimum rest requirements;
  - Drive while impaired by fatigue.
- PCBU's that provide heavy vehicles must ensure that their loads comply with relevant mass and dimension requirements

## SECTION 10: On-Site Management of Hazards and Risks (Site Rules) (continued)

### 10.55 GENERAL PROHIBITIONS - OTHER

All PCBU's have a duty of care to provide a safe and respectful workplace to all employees. The following actions and behaviours are not acceptable on a NEX Building Group's construction sites:

Any failure to follow the below rules will be considered an offence and will not be tolerated on any NEX Building Group sites:

- Work activities must be conducted within the DA allocated hours; this includes deliveries;
- No offensive or discriminatory language, aggressive or anti-social behaviour, public nuisance, vandalism, stealing or misappropriation will be acceptable on site;
- No animals or children are permitted on site;
- No firearms or other weapons allowed on site;
- A worker must not enter an Exclusion Zone during the operation of a crane;
- Any damage or unsafe areas must be reported to the Site Supervisor immediately;
- Never allow an unauthorised visitor(s) on site;
- Do not access restricted or dangerous areas or allow others to;
- Consider neighbouring properties when erecting temporary lighting;
- Comply with any reasonable safety instructions issued by the NEX Building Group.

## SECTION 11. Environmental Management

All workers are responsible for following environmental protection requirements. Penalties may be enforced if environmental protection requirements are not followed by any worker or (PCBU).

### 11.1 SOIL STOCKPILES

- Stockpiles must not be placed near stormwater drains, grates or drainage ditches;
- Batter stockpiles to 2:1 (horizontal to vertical) or less;
- Prevent flow of stormwater from stockpiles into drains with stabilisation or sediment fences;
- Long term stockpiles must be stabilised;
- Contaminated soils must be placed in designated areas.

### 11.2 WATER BODIES

- Silt fences or other barriers will be used to retain dirt/sediments from entering the stormwater system;
- Any damaged silt fences or barriers will be repaired or replaced immediately;
- Drain inlets, silt fences and other barriers will be regularly inspected, and any dirt/sediment build up will be cleaned away;

- Slurry will be captured and allowed to settle so that solid waste can be disposed of separate to wastewater;
- Concrete truck wash down area/pit is to be established in relevant position to avoid discharge to sewer/storm water. This could change as required. Area to be cleaned/concrete removed when hardened. When a truck washout area cannot be arranged, trucks will be directed away from site to wash out;
- Wet cutting of blocks/tiles must control wastewater and separate solid waste from water;
- Diversion bunds will be installed as necessary to minimise clean storm water from entering the work zone;
- Waste solvents and paint residue must be placed in the solvent drum if located on site. Where this is not possible, used brushes, rollers etc. must be taken off site to be cleaned;
- Waste paint (solid) paint containers, chemical containers, render and render containers should be removed from the site at the end of the day, or left to harden and disposed of in solid waste bins;

## SECTION 11. Environmental Management (continued)

- All chemicals are to be stored away from where it can be reasonably expected to flow to stormwater;
- Where possible a shake down area will be provided with a grate or coarse grade recycled concrete;
- Any sediment or concrete contamination on roads is to be removed by shovel and broom. No washing.

### 11.3 WASTE

- A recycling waste strategy plan may be developed which could identify which materials will be recycled by whom and where;
- All general waste to be placed in bins provided;
- All waste must be cleaned up daily and placed in the dedicated bins provided;
- The Site Supervisor must be advised immediately where excess waste is identified and/or any odorous solids/soils excavated at the workplace.

### 11.4 DUST, SMOKE & ODOURS

- Exposed soil and roads will be kept moist so that they do not generate excessive dust;

- Vehicles will not be driven on unsealed areas or off the established roads and tracks unless it is absolutely necessary;
- Workplace vehicles and plant will be maintained in good condition to minimise exhaust emissions;
- Vehicles are to be parked safely in designated areas only;
- Excess soil must be removed from wheels and vehicle bodies before leaving the site;
- Long term stockpiles will be stabilised or covered;
- Any dust generated by the use of equipment and power tools must be removed at the end of each shift by either:
  - Wet down and swept up;
  - Vacuum cleaning with an industrial vacuum cleaner;
  - Swept up by workers wearing approved dust masks and the area contained to prevent the spread of dust.
- Smoking is not permitted in the following areas:
  - In offices, site sheds, lunchrooms, toilets and any similar building or enclosed or partially enclosed structures;
  - In confined spaces, near fuel storage areas or whilst refuelling;

## SECTION 11. Environmental Management (continued)

- Whilst near or whilst handling flammable or combustible materials;
- In other areas where signage indicates no smoking;
- On sites where a no-smoking policy is in place.

In other areas smoking may be permitted however the comfort of others is to be considered at all times. Where there may be conflict the rights of the non-smoker will prevail.

### 11.5 NOISE & VIBRATION

Noise and vibration from construction works will not exceed Australian Standard AS 2436 or contravene the Development Application requirements. Subcontractors are encouraged to use plant with lower noise emissions and must:

- Supply hearing protection for their workers whether or not the work they are doing at the work site involves powered tools and equipment;
- Ensure workers are instructed to carry the supplied hearing protection and use it when the ambient noise is excessive noise levels may be excessive because of other worker of plant operating in the vicinity;
- Maintain plant and equipment regularly and wherever possible fit with manufacturers specified noise silencer;
- Not allow the use of plant and equipment with faulty or missing noise suppression if the plant and equipment has been manufactured with noise suppression;
- Position and orientate stationary plant and equipment away from nearby receptors;
- Minimise the simultaneous operation of high noise generating activities where possible;
- Noise or vibration monitoring may be employed if required as a result of complaints or where internally identified that emissions may be exceeding Australian Standards.

# SECTION 11. Environmental Management

(continued)

## 11.6 HAZARDOUS CHEMICALS/ SUBSTANCES

The controls and requirements for the management of Hazards Chemicals/ Substances can be found at Section 17 Hazardous Chemicals.

## 11.7 CONTAMINATED LAND

Where required a survey of the site will be conducted to ascertain the constituents of a contaminated site and a specific management plan will be implemented to cover such aspects as acid sulphates, sodic soil, lead, cadmium, arsenic, and other heavy metal contamination.

## 11.8 ENVIRONMENTAL PROTECTION AGENCY (E.P.A)

If there are any EPA issues resulting from operations on a NEX Building Group site, NEX Building Group must be informed immediately by contacting the Site Supervisor or telephone 24 hour emergency contact number. Failure to follow these requirements will result in any fines/penalties given to NEX Building Group being passed on to the responsible parties; some of these fines/penalties may be as much as \$8,000.

Pollution incidents posing material harm to the environment will be notified to each relevant authority as required by state legislation. ‘Relevant authority’ could mean but is not limited to:

- The appropriate regulatory authority (ARA);
- The Environment Protection Authority (EPA);
- The local authority, e.g., the local council;
- Fire and Rescue (000).

## 11.9 ARCHAEOLOGY & CULTURAL HERITAGE

The following controls will be implemented for sites where archaeological or cultural heritage requires protection:

- No disturbance or damage to existing known indigenous heritage sites or items;
- No disturbance or damage to existing non-indigenous heritage sites without prior consent or permit from the relevant state heritage body;
- Identification and protection of any new artefacts or heritage sites will be managed to ensure heritage sites are not knowingly destroyed, defaced or damaged.

## SECTION 11. Environmental Management (continued)

- Where deemed necessary due to council or developer requirements, further controls may be identified and implemented via a specific management plan for the management of Archaeological & Cultural Heritage aspects.

### 11.10 FLORA & FAUNA

Where the protection of native or significant flora and fauna species is identified, protection will be done in accordance with federal, state and local laws by implementing the following:

- Minimising the disturbance of vegetation and fauna habitat;
- In areas where pest ants are a hazard – preventing exportation or importation of declared pest ants by:
  - Restricting movement of soils, mulches etc. within a restricted area without a movement certificate or declaration;
  - No movement of soil from a controlled area to a non-controlled area;
  - Brushing and washing down of soiled vehicles before leaving site conducting a site inspection (where deemed a requirement through site risk assessment);

- Where deemed required a specialised plan for the management of pest ants may be developed and implemented;
- Identifying and protecting selected trees and vegetation that are to be preserved prior to commencement of construction activities;
- Preventing noxious weed infestation through strict control of imported topsoils/ mulches etc;
- Where deemed necessary due to council or developer requirements, further controls may be identified and implemented via a specific management plan for the management of flora & fauna aspects.

## SECTION 12. Emergency Preparedness

### 12.1 INCIDENTS & NEAR MISSES

Accidents, incidents and near misses must be reported immediately to the Site Supervisor. This will allow completion of an investigation to document all details and facts as soon as possible after the event, to ensure preventative measures are put in place.

Where required in the contract, incidents will be reported to the developer/client in accordance with their specific requirements.

### 12.2 EMERGENCY PROCEDURES AND FIRST AID

All contractors must ensure that they have a relevant sized first aid kit based on their work activity and the size of their work group. Each PCBU should also have a trained first aider in each work group.

All NEX Building Group Site Supervisors are trained in first aid and have a first aid kit at their disposal for use in the event of an incident.

If an emergency occurs on a NEX Building Group site, contact the Site Supervisor immediately or telephone 24 hour emergency contact number displayed on the site signage located at the front site security fence.

#### WHEN PHONING FOR HELP SAY:

1. **WHERE** the emergency is: give the address/name of the site and details about the specifics of entry;
2. **WHAT** has happened: advise the exact nature of the injury;
3. **WHAT** is being done;
4. **WHO** is calling: leave a site or contact telephone number;
5. **WAIT** to be told what to do before hanging up.

Whilst waiting for the authorities, keep calm, do not interfere with the accident scene and make sure the injured person is not moved; unless there is a risk of further injury to the patient or others. Reassure the injured person that help is on the way. Assist the authorities to locate and access the accident site.



## SECTION 12. Emergency Preparedness *(continued)*

### 12.3 ELECTRIC SHOCK

In the case of an electric shock, follow the below process:

- Notify emergency services (ambulance) immediately (dial 000);
- Do not touch the victim, or any live electrical components;
- Disconnect the power if possible, before trying to assist someone suffering from electric shock;
- Obtain advice from the 000 operator and consider your own health and safety if you undertake any action to assist and injured person who has received electric shock;
- Remove injured person from the electric supply without directly touching them, by using a non-conductive material (for example – dry wood, rubber, plastic);
- Apply artificial respiration if qualified or contact first aid officer;
- Immediately notify NEX Building Group of the incident.

### 12.4 IN THE EVENT OF A SERIOUS ACCIDENT – NOTIFIABLE INCIDENT

The NEX Building Group will report all notifiable incidents to the relevant state safety regulator in accordance with legislative requirements.

A ‘notifiable incident’ under the work health and safety legislation relates to:

- the death of a person;
- a serious injury or illness of a person;
- a potentially dangerous incident.

Examples of these incidents include IMMEDIATE TREATMENT for the following:

- as an in-patient in a hospital;
- the amputation of any part of the body;
- a serious head injury;
- a serious eye injury;
- a serious burn;
- the separation of skin from an underlying tissue (such as de-gloving or scalping);
- a spinal injury;
- loss of a bodily function;
- serious lacerations;
- or medical treatment within 48 hours of exposure to a substance.

## SECTION 12. Emergency Preparedness (continued)

Notification is also required for any infection where the work is a significant contributing factor.

Some types of dangerous incidents must be notified even if no-one is injured. The regulator must be notified of any incident in relation to a workplace that exposes any person to a serious risk resulting from an immediate or imminent exposure to:

- An uncontrolled escape, spillage, or leakage of a substance;
- An uncontrolled implosion, explosion, or fire;
- An uncontrolled escape of gas or steam;
- An uncontrolled escape of a pressurised substance;
- Electric shock;
- The fall or release from a height of any plant, substance, or thing;
- The collapse, overturning, failure, or malfunction of, or damage to, any plant that is required to be design or item registered under the WHS Regulations, for example a collapsing crane;
- The collapse or partial collapse of a structure;
- The collapse or failure of an excavation or of any shoring supporting an excavation;

- The inrush of water, mud, or gas in workings, in an underground excavation or tunnel;
- The interruption of the main system of ventilation in an underground excavation or tunnel.

In the event of a notifiable incident, preserve the site and its surrounding area of at least 4m. The site must not be disturbed in any way other than to assist an injured person or make the area safe. Non-disturbance applies for 36 hours after the occurrence or for such time as directed by the safety regulator or police.

### 12.5 FIRE & OTHER EVACUATION PROCEDURE

In the event of an emergency on-site the most senior worker for each subcontractor will oversee the evacuation of their workers. Where emergency wardens are available, they will assist with the evacuation. All persons must:

- Evacuate to a safe location away from the site, normally the entrance gate to the construction site or a safe distance away from danger;
- Respond immediately to the evacuation alarm;

## SECTION 12. Emergency Preparedness (continued)

- Remain at the safe location until instructed by their supervisor or emergency services;
- Advise the NEX Building Group Site Supervisor of the situation;
- Call the relevant emergency services at the earliest opportunity.

Emergency evacuation procedures on multi residential sites will be tested at least every 3 months. NEX Building Group have completed a risk assessment and determined that testing of individual single dwelling and small multi-residential projects is reasonably practicable; however, review of emergency procedures is completed on a case-by-case basis through incident investigation.

# SECTION 12. Emergency Preparedness (continued)

## 12.6 CRITICAL INCIDENT RESPONSE FLOWCHART

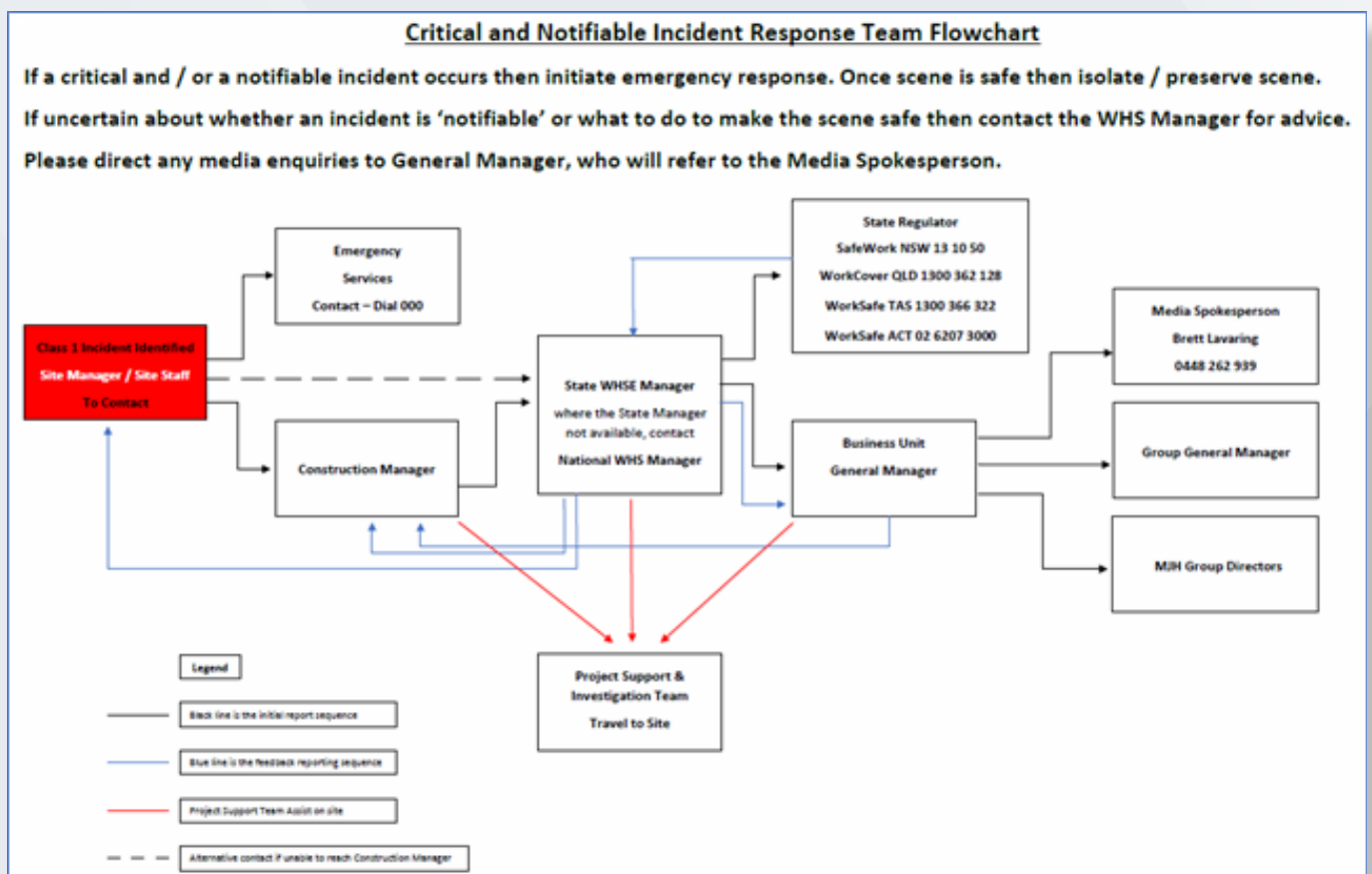

## SECTION 13. Risk Management

### 13.1 HAZARD IDENTIFICATION PROCEDURE

Hazards are defined as a source of potential harm to people or a situation with potential to cause injury or loss to plant, property, or equipment.

#### HAZARD IDENTIFICATION:

This is the process of identifying all situations or events that could give rise to injury, illness or damage to plant or property. Hazards can be identified by the following methods:

- Direct report from employees and sub-contractors;
- NEX Building Group WHSE Incident/Hazard Report Form;
- Industry information;
- Health and safety meetings;
- Workplace inspections;
- SDS;
- Safety alerts.

## SECTION 13. Risk Management (continued)

### 13.2 HIERARCHY OF CONTROL MEASURES

#### 1. ELIMINATE OR CONTROL THE HAZARD

Elimination should always be the first preference as it is a permanent solution. Where hazards cannot be eliminated then control them to minimise the risk. Think about changing processes to eliminate the hazard altogether, such as replacing faulty equipment.

#### 2. SUBSTITUTE

If the hazard cannot be eliminated altogether, replace the hazardous plant, equipment, substance or process with a less hazardous one. Think about using a different, less dangerous piece of plant or equipment, substance or process.

#### 3. ISOLATION

If the hazard cannot be substituted, consider isolating the hazard. This separates the person the person from the source of danger. Think about isolating or enclosing hazards

#### 4. MINIMISE BY ENGINEERING MEANS

If you cannot eliminate the hazard or change the equipment, product or material, introduce engineering controls to place a barrier between people and the hazard. Think about fitting guards to machinery, isolating or enclosing hazards, and using mechanical aids.

#### 5. INTRODUCE ADMINISTRATIVE CONTROLS

Introduce procedures and provide instructions to reduce the exposure to the hazard. Think about implementing hazard training, varying work methods and times, using tag & lock out systems and training people in correct use of resources.

#### 6. USE PERSONAL PROTECTION

PPE is the least effective way of dealing with hazards. When introducing PPE to control a risk to health and safety, always refer to any relevant SDS and always follow manufacturers guidelines.

## SECTION 13. Risk Management (continued)

### 13.3 RISK ASSESSMENT MATRIX

The Risk Assessment Matrix determines the priority that should be placed on controlling the hazard.

#### PRIORITY RATING

1. A priority rating of '1' means the hazard must be controlled immediately; and the task should not be performed until adequate control measures are in place.
2. A priority rating of '2' means that temporary control measures should be implemented immediately; with permanent control measures implemented within 7 days.
3. A priority rating of '3' means that the hazard should be controlled as soon as practicable, but not longer than 14 days.
4. A priority rating of '4' means that the hazard should be controlled when practicable, usually within 1 month.
5. A priority rating of '5' means that the hazard should be controlled when practicable, usually within 3 months.
6. A priority rating of '6' means that the hazard is to be controlled when practicable, usually within 6 - 12 months.

## SECTION 13. Risk Management (continued)

<p><b>THINK ABOUT:</b>                      Firstly, determine how severely could it hurt or how ill could it make someone? →</p> <p>Then consider how likely it is to happen? ↓</p>	<p><b>VERY LIKELY</b></p> <p>Could happen any time</p>	<p><b>LIKELY</b></p> <p>Could happen sometime</p>	<p><b>UNLIKELY</b></p> <p>Could happen some time</p>	<p><b>VERY UNLIKELY</b></p> <p>Could happen but probably never will</p>
Kill or cause permanent disability or ill health	1	1	2	3
Long term illness or serious injury	1	2	3	4
Medical attention and several days off work	2	3	4	5
First aid needed	3	4	5	6



# SECTION 13. Risk Management (continued)

## HAZARD IDENTIFICATION, RISK ASSESSMENT & CONTROL FLOWCHART

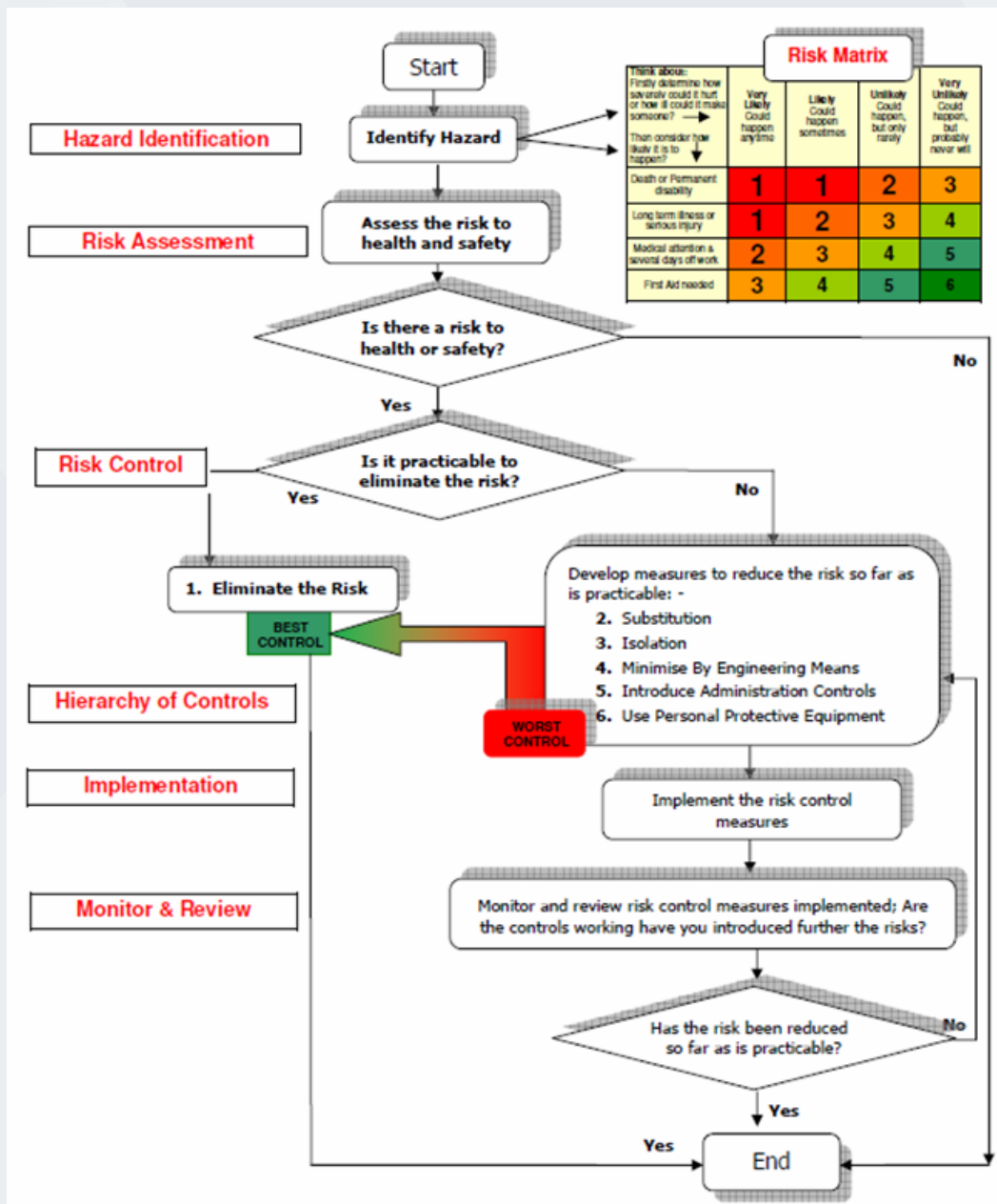

Refer to 10.8 WHSE Issue Resolution of this document when parties fail to agree controls or corrective actions. Contact can be made with the WHSE Representative for further advice and assistance.

## SECTION 14. Safe Work Method Statements (SWMS)

A SWMS is a document that sets out the high-risk construction work activities to be carried out at a workplace, the hazards arising from these activities and the measures to be put in place to control the risks.

Suppliers of goods and services will also be required to submit a SWMS if the risks associated with the work meet one of the high-risk construction work tasks as listed below.

The NEX Building Group consider the following 16 High-Risk Construction work tasks as defined by the legislation to be relevant to our business and therefore require a High-Risk SWMS to be submitted:

- Is carried out in or near a confined space;
  - Is carried out in or near:
    - A shaft or trench with an excavated depth greater than 1.5 metres;
    - A tunnel;
  - Is carried out on or near pressurised gas distribution mains or piping;
  - Is carried out on or near chemical, fuel or refrigerant lines;
  - Is carried out on or near energised electrical installations or services;
  - Is carried out in an area that may have a contaminated or flammable atmosphere, or
  - Involves tilt-up or precast concrete;
  - Is carried out on, in or adjacent to a road, railway, shipping lane or other traffic corridor that is in use by traffic other than pedestrians;
  - Is carried out in an area at a workplace in which there is any movement of powered mobile plant;
  - Is carried out in or near water or other liquid that involves a risk of drowning.
- Involves a risk of a person falling more than 2 metres;
  - Involves demolition of an element of a structure that is load bearing or otherwise related to the physical integrity of the structure;
  - Involves, or is likely to involve, the disturbance of asbestos;
  - Involves structural alterations or repairs that require temporary support to prevent collapse;

# SECTION 14. Safe Work Method Statements (SWMS) (continued)

## 14.1 SAFE WORK METHOD STATEMENTS CONTENT

Safe Work Method Statements must be submitted to and approved by the NEX Building Group prior to the commencement of work on site. Its primary purpose is to help persons conducting a business or undertaking (PCBUs), supervisors and workers implement and monitor the control measures established at the workplace to ensure high risk construction work is carried out safely. A SWMS must as a minimum:

- Identify the high-risk construction work activities to be carried out;
- Specify the hazards and risks to health and safety arising from those activities;
- Describe the measures to be implemented to control the risks;
- Describe how the control measures are to be monitored and reviewed.

## 14.2 SAFE WORK METHOD STATEMENT REVIEWS

The SWMS will need to be resubmitted every 12 months to ensure it remains applicable. In addition, the following applies:

- All workers must have read, understood, agreed with and signed the SWMS (Larger entities may supply training registers with dates of their workers trained in the SWMS);
- Any risks not covered on site in the SWMS must be included in the workers risk assessment.

Where SWMS submitted by the vendor do not meet the NEX Building Group requirements, the vendor must review their SWMS and add to or amend the content. The NEX Building Group will assist vendors as required.

## SECTION 15. Inspection and Testing

### 15.1 MOBILE PLANTS

All mobile plants must be maintained in accordance with the manufacturer's instructions, and relevant Australian Standards, and have all relevant servicing details, logbooks etc. available for inspection on request.

Pre-start operational checks must be done on all equipment prior to each use daily.

Cranes and concrete boom pumps must be item registered with the state safety regulator and have proof of the current registration available on site.

### 15.2 HIRE EQUIPMENT

All hire equipment must be inspected at time of delivery. Relevant service inspection paperwork and logbooks must accompany all hired equipment.

### 15.3 HANDHELD POWER TOOLS

All tools and equipment must be serviced and maintained in accordance with manufacturer's instructions. A visual inspection of the tool must be done prior to its use daily.

### 15.4 SAFETY HARNESES & LANYARDS

All harnesses and lanyards must be checked according to the manufacturer's instructions and in accordance with the relevant Australian Standards.

### 15.5 OTHER EQUIPMENT

Procedures must be in place for the regular inspection and maintenance in accordance with manufacturer's instructions or guidelines, relevant standards and codes of practice pertaining to the particular type of equipment.

## SECTION 16. Materials Handling, Storage & Delivery

### 16.1 MATERIALS HANDLING & STORAGE

All products and materials must be stored in such a way to ensure that they do not cause a danger by:

- Blocking access and egress;
- Stacking too high causing a potential crush hazard;
- The method of storage creates a manual handling hazard;
- Opening and leaking during transportation;
- No contractor equipment or material is to be stored on sites without permission from Site Supervisor.

### 16.2 FLAMMABLE SUBSTANCES & COMBUSTIBLE LIQUIDS

To eliminate the risk of fire or explosion the following controls are required:

- Eliminate ignition sources (sparks, smoking, flames and hot surfaces);
- Use the smallest amount of flammable liquid necessary in the work area;
- Keep storage areas cool and dry;
- Store flammable and combustible liquids away from incompatible materials (e.g., oxidizers), and in approved containers.

### 16.3 DELIVERIES

The Site Supervisor must be notified prior to delivery of materials. The following information is required at time of notification:

- Type of goods and hazards;
- Time of delivery;
- Unloading location;
- Method of unloading.

## SECTION 17. Hazardous Chemicals/ Substances

A hazardous chemical is a substance or material which has the potential to harm the health or safety of a person or others in the workplace through being used or stored at the workplace. The following section outlines the procedures and systems that will be adopted by NEX Building Group.

All contractors must maintain a register of all hazardous chemicals that are used on any NEX Building Group sites. The register must contain a relevant and up to date Safety SDS for each of the hazardous chemicals/substances used. No hazardous chemicals/substances are allowed to be stored on site without permission and must be removed by the trade contractor at the end of their working day. PC is to be notified what chemicals/substances is on site.

Any first aid attendant should also be aware of the register of SDSs for easy access. Some examples of products requiring SDSs are:

- Paints, varnishes, and solvents;
- Glues, adhesives, jointing compounds, and concrete sealants;
- Industrial cleaning agents;
- Insulation materials;
- Cement and refractory products;
- Pesticides and herbicides;

- Welding fluxes and rods;
- Chemical anchors;
- Gases, inert and toxic;
- Motor fuels and lubricants;
- Chemicals of a like nature.

### RISK ASSESSMENT

A risk assessment is to be undertaken to evaluate the health and safety risks to employees arising from the safe storage, use and handling of hazardous chemicals in the workplace and to determine the measures necessary to control these risks.

The assessment will record and include:

- The identification of hazardous chemicals in the workplace;
- The nature of the hazard to health and safety;
- The degree of risk to health and safety;
- The measures required to control the exposure;
- Whether health surveillance is necessary;
- The induction and training required for employees.

## SECTION 17. Hazardous Chemicals/ Substances (continued)

### CONTROL

The purpose of control is to minimise employee exposure to hazardous chemicals thereby preventing adverse health effects, which could occur from such exposure.

Control of hazardous chemicals will be achieved through progressive application of the following hierarchy of control measures:

- Elimination of hazardous chemicals from the workplace;
- Substitution by less hazardous chemicals;
- Isolation of the process to control the emission of hazardous chemicals;
- Engineering control, including local exhaust ventilation for vapour, gases or particulate, to contain or minimise hazardous chemicals or processes;
- Adoption of safe work practices, including changes to work methods which minimise exposure to hazardous chemicals;
- Where other effective means of controlling the hazard are not workable, suitable approved personal protective equipment will be provided which conforms to the relevant standard. The correct PPE must be used as, when and where required. It should be kept clean and maintained in an appropriate manner for the use it was intended for;
- SDS will be available to the workers using the chemicals;
- All containers of chemicals supplied to, used or handled in the workplace will be labelled to allow people to use the chemicals safely. This includes containers into which chemicals are decanted unless the entire decanted chemical is to be used immediately;
- High standards of personal hygiene must be maintained by washing thoroughly and removing all protective clothing before eating, drinking and smoking;
- Defects discovered in any control measures including Personal Protective Equipment must be reported promptly to the Site Supervisor or the workers own supervisor for immediate corrective actions;
- No smoking within 10 metres of any flammable goods/chemicals;
- Chemicals or chemical containers must not be disposed of in general purpose bins;
- Chemicals must be kept out of stormwater drains or the sewer;
- Immediately clean up any spills;
- NEX Building Group must be notified immediately of any paint, fuel, dangerous good or hazardous chemical spill;

## SECTION 17. Hazardous Chemicals/ Substances (continued)

- Ensure clean up and disposal of hazardous substances are in accordance with the requirements in the SDSs and ensure that appropriate PPE is made available and worn;
- Refuelling of plant is to be from a mini tanker, off site preferably;
- Minor plant – use absorbent pads especially around fuel tank;
- Any PCBU that carries dangerous goods or hazardous chemicals must carry a spill kit.



## SECTION 18. Health Surveillance & Monitoring

All PCBUs that have workers that are exposed to a substance or mixture in an airborne concentration that may exceed the exposure standard must ensure that they carry out air monitoring.

The purpose of monitoring is to derive a quantitative estimate of the exposure of employees to hazardous chemicals and airborne contaminants. Monitoring is relevant to both assessment and control. Monitoring involves the periodic and/or continuous sampling of workplace atmospheres of personnel, to determine the risk of exposure to hazardous chemicals. Monitoring is relevant to assessment and control.

The purpose of health surveillance is to ensure the health of employees is maintained while working with hazardous chemicals and substances (examples include but are not limited to lead, silica dust, fibreglass insulation, petrol, wood dust, manganese, and isocyanides). Early adverse health effects from exposure to hazardous chemicals and substances may be detected through health surveillance.

Records of health monitoring of employees must be maintained for a period of 30 years. The retention of records for this period of time is necessary because some adverse health effects, such as cancers, may take a long time to develop.

Records must include inventories of hazardous chemicals, results of workplace monitoring and employee health surveillance.

## SECTION 19. Rehabilitation & Return to Work

### NEX BUILDING GROUP EMPLOYEES

The NEX Building Group is committed to the rehabilitation of injured workers. The business aims to conduct injury management in the workplace to ensure that all injured employees have the opportunity to recover and return to work by:

- Providing full support throughout the rehabilitation process to minimise the effects of the injury and ensure that an early return to work is a normal practice and expectation;
- Ensuring early access to rehabilitation services, e.g., accredited rehabilitation providers for injured workers as required;
- Providing suitable duties for an injured worker as an integral part of the rehabilitation process;
- Consulting with workers and where applicable, any industrial union representing them, to ensure that the return-to-work program operates smoothly and effectively;
- Informing workers of their rights in relation to a Workers Compensation claim including the choice of doctor and accredited rehabilitation provider;

- Providing access to interpreter services as appropriate;
- Ensuring that participation in return-to-work program will not of itself prejudice an injured worker;
- Advising employees that participation in rehabilitation is voluntary but non-participation may result in reduced weekly benefits.

### CONTRACTORS, SUB-CONTRACTORS AND THEIR WORKERS

All subcontractors must comply with the NEX Building Group rehabilitation and return to work policy for ill or injured workers whose injuries or illnesses occurred, or were otherwise aggravated, at the work site. This includes ensuring:

- The contractor, subcontractor and workers have access to a qualified rehabilitation and return to work coordinator if required by law (employee or outsourced);
- The contractor, subcontractor must notify the NEX Building Group as soon as possible after a worker sustains an injury or illness, due to legal obligations on reporting notifiable incidents;

## SECTION 19. Rehabilitation & Return to Work (continued)

- The injured or ill worker is provided with suitable duties whenever possible;
- The subcontractor, or the subcontractor's rehabilitation and return to work coordinator, makes regular contact with the injured worker to check on progress and actively assists in the worker's rehabilitation;
- The subcontractor provides the PC with regular updates on the progress of the worker within the constraints of the confidentiality clauses of any relevant workers' compensation legislation.

# SECTION 19. Rehabilitation & Return to Work (continued)

## WORKERS COMPENSATION RETURN-TO-WORK FLOW CHART (RTW PROGRAM)

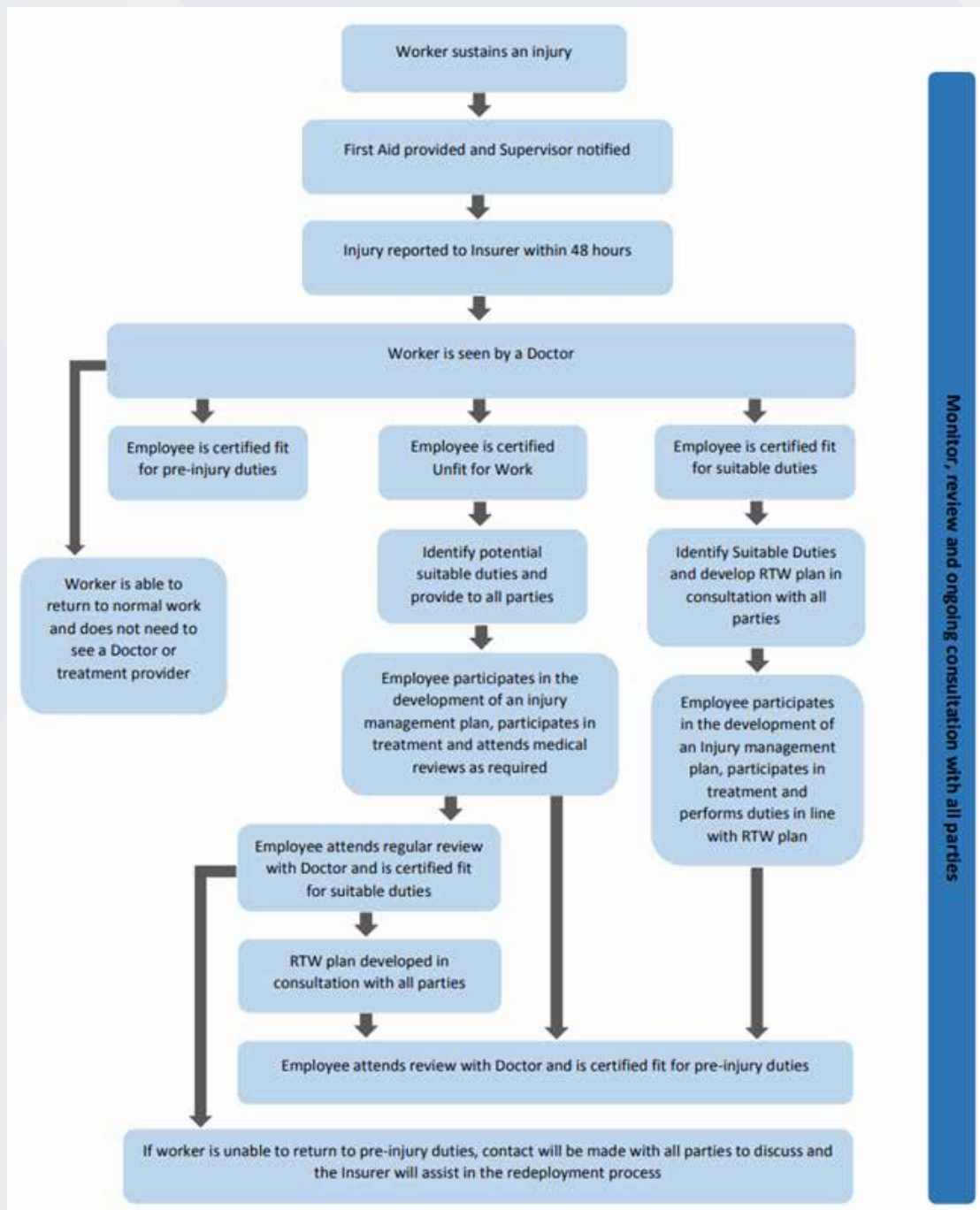

# SECTION 20. Measurement, Evaluation & Review

## 20.1 SITE INSPECTIONS & CONTRACTOR REVIEW

Measurement and evaluation of the management of safety and environmental hazards on the construction site(s) and compliance with the management plan will be done via any of the following:

- Visual inspections;
- Documented inspections;
- External audits;
- Task observation;
- Contractor risk assessments;
- Incident & hazard reports;
- Incident investigations;
- Regulator inspections;
- SWMS review;
- Contractor/supplier feedback.

## 20.2 SYSTEMS AUDITS INTERNAL

The WHSE management system will be audited internally on a yearly rolling audit schedule and will:

- Examine each of the key system elements;
- Be capable of identifying deficiencies in the system and plans and their implementation;
- Be carried out by persons with skills, competency and knowledge of the system plans;
- Be fully documented recorded, and reviewed by senior management;
- Be available for review by external auditors;
- Result in corrective actions being undertaken to rectify any deficiencies in the system or plans;
- Include follow-up actions to assess the effectiveness of any corrective actions.

## EXTERNAL

External audits of the system will be completed by an external provider annually to provide an unbiased report of our systems and to ensure compliance and continued certification to ISO45001 for the businesses that hold certification.

## SECTION 20. Measurement, Evaluation & Review (continued)

### 20.3 CONTRACTOR COMPLIANCE

The NEX Building Group have a contractor compliance pre-qualification system in place that reviews and assesses contractor’s safety systems prior to allowing them to work for the Group. Contractors are reviewed against set criteria. Documents required include but are not limited to:

- Business details;
- CGI (white/red/blue cards);
- Contractor and or specialist trade licences;
- Insurances;
- HRW licences;

and samples of:

- Safe Work Method Statements (SWMS);
- Site specific risk assessments;
- Worker training;
- Plant and equipment registers;
- Plant and equipment maintenance records and item registration where required.

SWMS are reviewed and where deemed to be inadequate, contractors are required to review and amend the SWMS accordingly and resubmit.

Once a contractor has prequalified and been entered into the system, an annual submission of their compliance documentation is required to keep them active in our systems and ensure they are maintaining compliant documentation including licences, insurances, SWMS etc.

### 20.4 DISCIPLINARY PROCEDURES

Non-compliance with safety procedures, legislation and instructions may result in various sanctions or disciplinary procedures for NEX Building Group employees, subcontractors or workers. Disciplinary procedures may include but are not limited to:

- Instant removal from site for serious breaches;
- Instant dismissal;
- Referral to authorities;
- Transfer to another work site or position;
- Back-charges;
- Withholding progress payments;
- Cancellation of contract;
- Non-compliance notices;
- Verbal warnings;
- Written warnings;
- Toolbox Talks.

## SECTION 20. Measurement, Evaluation & Review (continued)

### 20.5 NON-COMPLIANCE NOTICES

Where a matter of WHSE non-compliance of products, materials, and equipment or work practices is identified, a Non-Compliance Notice may be issued. The notice will detail the area(s) of non-compliance and corrective actions required.

If issued to trade/contractor, they must complete and return the signed non-compliance notice to NEX Building Group verifying the agreed corrective actions have been or will be completed by the agreed due date. Copies of Non-Compliance notices will be kept on their contractor file for future reference.

Failure to affect an improvement after issue of a notice or not comply within a pre-determined time frame, will lead to a review by NEX Building Group. Where a person or a sub-contractor is in continuous breach of safety or quality standards, cancellation of the person or sub-contractor's contract may result.

## SECTION 21. Documentation and Data Control

### 21.1 DOCUMENT CONTROL

The NEX Building Group employs a Document Control Procedure to manage controlled documents, including but not limited to policies, procedures, standard work instructions, forms, manuals, plans and reports related to activities carried out. NEX Building Group documents are assigned a Process Owner within the business who is responsible for the adequacy and currency of the content and ensuring periodic review. They are accountable for notifying external parties affected by changes to documents within their responsibilities. Refer to Document Control Procedure for further information on the processes for managing controlled NEX Building Group documentation.

NEX Building Group is committed to reducing waste documentation & unnecessary printing of documents and therefore operates a paperless business where possible. In order to achieve this process, we utilise the following processes:

- Project documents are stored in specific client files on the system sever;
- Additional documentation produced is scanned into specialised software system for easy access, archiving and retrieval;
- Site Supervisors have access to these systems via their mobile laptops;
- Construction Mangers & Site Supervisors also use a specialised workflow software system for construction.



## SECTION 21. Documentation and Data Control (continued)

### 21.2 GENERAL RECORDS

The NEX Building Group will endeavour to retain and manage the following types of records:

- Manufacturer’s information on all equipment and substances currently or previously in use;
- Results from testing and reports on faulty equipment;
- Incident records and statistics;
- Employee qualifications, competency and training;
- PPE Registers;
- Contractor qualifications, competencies and training, SWMS & other relevant documentation;
- Induction Registers;
- Incident reports;
- Investigation reports and investigation recommendations;
- Injury Registers;
- WHS Committee Meetings minutes;
- Site Supervisor Construction Meetings/ Toolbox Talks minutes;
- Site Inspections/Audits;
- Improvement/Prohibition Notices issued but the state safety regulator;
- Copies of complaints;
- Non-Compliance Reports.



1300 183 346  
whs@nexbg.com.au

